

# MONTANA®

THE WORLD OF EXCELLENCE



VERBRAUCHSMATERIAL

Consumables and accessories

Consommables et accessoires

Materiale di consumo ed accessori

# INHALTSVERZEICHNIS

INDEX / SOMMAIRE / SOMMARIO

<b>VOLVR loading system</b>	<b>10 - 13</b>	<b>Pflegemittel &amp; Maschinenzubehör</b>	<b>46 - 49</b>
Der Fortschritt in der Automation / The future of automation Des progrès dans l'automatisation / Il progresso nell'automazione		Care products and accessories for machines Produits d'entretien et accessoires pour machines Prodotti per la manutenzione ed accessori per macchine	
<b>Technologie GRIPtech</b>	<b>14 - 15</b>	<b>Hygienemittel &amp; Ionisation</b>	<b>49 - 50</b>
Technology GRIPtech / Technologie GRIPtech Tecnologia GRIPtech		Hygienic products and ionization / Produits hygiéniques et ionisation Prodotti igienici e ionizzazione	
<b>Belagsreparatur</b>	<b>16 - 23</b>	<b>Werkstatteinrichtung &amp; Werkzeuge</b>	<b>51 - 53</b>
Base repair / Réparation des revêtements Riparazione delle superfici		Workshop tools / Aménagement de l'atelier et outils Attrezzatura da officina	
<b>Abrichtwerkzeuge</b>	<b>24 - 25</b>	<b>Bindungsmontage</b>	<b>53 - 56</b>
Dressing tools / Outils de dressage / Strumenti di rettifica		Binding mounting / Matériel pour le montage des fixations Materiale per il montaggio degli attacchi	
<b>Schleifscheiben für Tuning-System</b>	<b>28</b>	<b>Flip Clip &amp; Werkstatt Racks</b>	<b>56 - 61</b>
Grinding discs for tuning system Disques de ponçage pour le système tuning Dischi di rettifica per il sistema tuning		Flip Clip & workshop racks / Flip Clip & chariots d'atelier Flip Clip & carrello da officina	
<b>Schleifsteine &amp; -Ringe</b>	<b>29</b>	<b>MONTANA – Werbemittel</b>	<b>64 - 66</b>
Grinding stones and rings / Meules et disques de ponçage Mole e dischi di levigatura		Advertising material / Matériel de publicité Materiale pubblicitario	
<b>High class Rennkanten</b>	<b>32 - 33</b>	<b>SKICLICKEK &amp; BOOT BIB</b>	<b>67</b>
High class race edges / High class carres de compétition High class lamine di gara		SKICLICKEK & BOOT BIB for rental SKICLICKEK & BOOT BIB pour la location SKICLICKEK & BOOT BIB per il noleggio	
<b>Seitenkanten-Schleifbänder</b>	<b>33 - 34</b>	<b>MONTANA BEKLEIDUNG</b>	<b>68 - 69</b>
Side edge sanding belts / Bandes de ponçage pour carres latérales Nastri abrasivi per lamine laterali		MONTANA apparel / Vêtements MONTANA Abbigliamento MONTANA	
<b>Schleifbänder &amp; Zubehör</b>	<b>35</b>	<b>Steigfelle von MONTANA</b>	<b>72 - 73</b>
Sanding belts and accessories Bandes de ponçage et accessoires Nastri abrasivi ed accessori		Climbing SKINS from MONTANA Peaux de montée de MONTANA / Pelli di foca MONTANA	
<b>Wachsen, Polieren &amp; Zubehör</b>	<b>36 - 38</b>	<b>Pflege &amp; Zubehör</b>	<b>74 - 78</b>
Waxing, polishing and accessories Fartage, polissage et accessoires Sciolinatura, lucidatura ed accessori		Care & accessories / Soins & accessoires / Cura e accessori	
<b>Kantenpräparation &amp; Schutzausrüstung</b>	<b>39 - 41</b>	<b>Verbrauchsmaterial Maschinen</b>	<b>82 - 97</b>
Side edge preparation and protective equipment Préparation des carres et équipement de protection Preparazione delle lamine ed attrezzatura di protezione		Machine consumables Matériaux de consommation par machine Materiale di consumo per macchine	
<b>Schablonen</b>	<b>41 - 42</b>	<b>Jetbond</b>	<b>98 - 99</b>
Templates / Gabarits / Sagome		Bindungsmessung / Binding measurement Mesure des fixations / Misurazione dell'attacco	
<b>Schleifmittelkonzentrat &amp; Pflegemittel</b>	<b>43 - 45</b>	<b>Übersicht MONTANA Maschinen</b>	<b>102 - 118</b>
Abrasive concentrate and care products Concentré abrasif et produits d'entretien Prodotti abrasivi concentrati e prodotti di cura		Overview MONTANA machines Vue d'ensemble machines MONTANA Panoramica macchine MONTANA	

## Mit MONTANA sind Sie auf der sicheren Seite

Von Europa, über Nordamerika bis Australien: die führenden Betriebe im Ski & Boardservice vertrauen auf MONTANA. Die Erfahrung vom Entwickler des ersten maschinellen Steinschliffs verpflichtet zu Qualität ohne Kompromisse.

## Zahlungs- und Lieferkonditionen

Die Preise verstehen sich in Schweizer Franken (CHF) rein netto, exkl. 8.1% MWSt. Lieferung ab Werk Stans, Zahlung 30 Tage netto. Bei Bestellungen unter CHF 100.– wird ein Kleinmengenzuschlag von CHF 10.– belastet. Im übrigen gelten die allgemeinen Zahlungs- und Lieferkonditionen.

## Be on the safe side with MONTANA

From Europe to North America to Australia: the leading ski & boardservice shops trust MONTANA. The experience from the developer of the first stone grinding machine commits to quality without compromise.

## Payment and delivery conditions

The prices given are net prices in Swiss francs (CHF), not including 8.1% VAT. Delivery from our headquarters in Stans, full payment within 30 days. Orders under 100.– CHF are subject to an additional small orders surcharge of 10.– CHF. The general payment and delivery conditions apply.

## Avec MONTANA vous faites le bon choix

De l'Europe à l'Amérique du Nord jusqu'en Australie: les entreprises leader dans le service des skis & snowboards font confiance à MONTANA. L'expérience de l'inventeur des premières ponçuses à meule oblige la qualité sans compromis.

## Conditions de paiement et de livraison

Prix en Francs Suisses (CHF) net, sans 8.1% TVA. Livraison départ Stans. Paiement: 30 jours net. Pour des commandes de moins de CHF 100.– une surtaxe pour petites quantités de CHF 10.– est ajoutée. Autrement, nos conditions générales seront appliquées.

## Con MONTANA siete affiancati al meglio

Dall'Europa, al Nord America all'Australia. Le imprese leader per i servizi sci e snowboard si affidano a MONTANA. L'esperienza dell'inventore della prima levigatrice a mola significa qualità senza compromessi.

## Condizioni di pagamento e di fornitura

I prezzi sono da intendersi in Franchi Svizzeri (CHF) al netto, con 8.1% di IVA esclusa. Consegna dalla fabbrica di Stans, pagamento entro 30 giorni netto. In caso di ordinazioni di valore inferiore a CHF 100.– sarà addebitato un sovrapprezzo per piccole quantità pari a CHF 10.–. Per il resto, valgono le condizioni generali di pagamento e di fornitura.

## © Montana Sport International AG

Produkt- und Preisänderungen vorbehalten.

Products and prices are subject to change without notice.

Sous réserve de modification de produits et prix.

Con riserva di modifiche ai prodotti e ai prezzi.

**MONTANA**  
CRYSTAL GLIDE FINISH

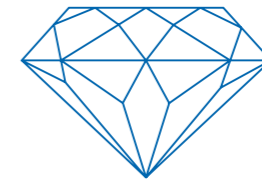

! Bei den mit einem Stern (\*) markierten Artikelnummern handelt es sich um Artikel mit Netto-Spezialpreisen.

Item numbers marked with a star (\*) are items with special net prices.

Pour les numéros d'articles identifiés par un astérisque (\*) il s'agit d'articles bénéficiant d'un prix préférentiel net.

I numeri di articoli contrassegnati da un (\*) hanno un prezzo netto speciale.

A = Auslaufend – Lieferung nur noch solange Vorrat.

A = Running out – Delivery only while stocks last.

A = Sortant – Livraison jusqu'à épuisement des stocks.

A = In via di esaurimento – Fornitura possibile fino ad esaurimento scorte.



# AUFBEWAHRUNGSSYSTEME

STORAGE SYSTEMS / SYSTÈMES DE RANGEMENT / SISTEMI DI DEPOSITO

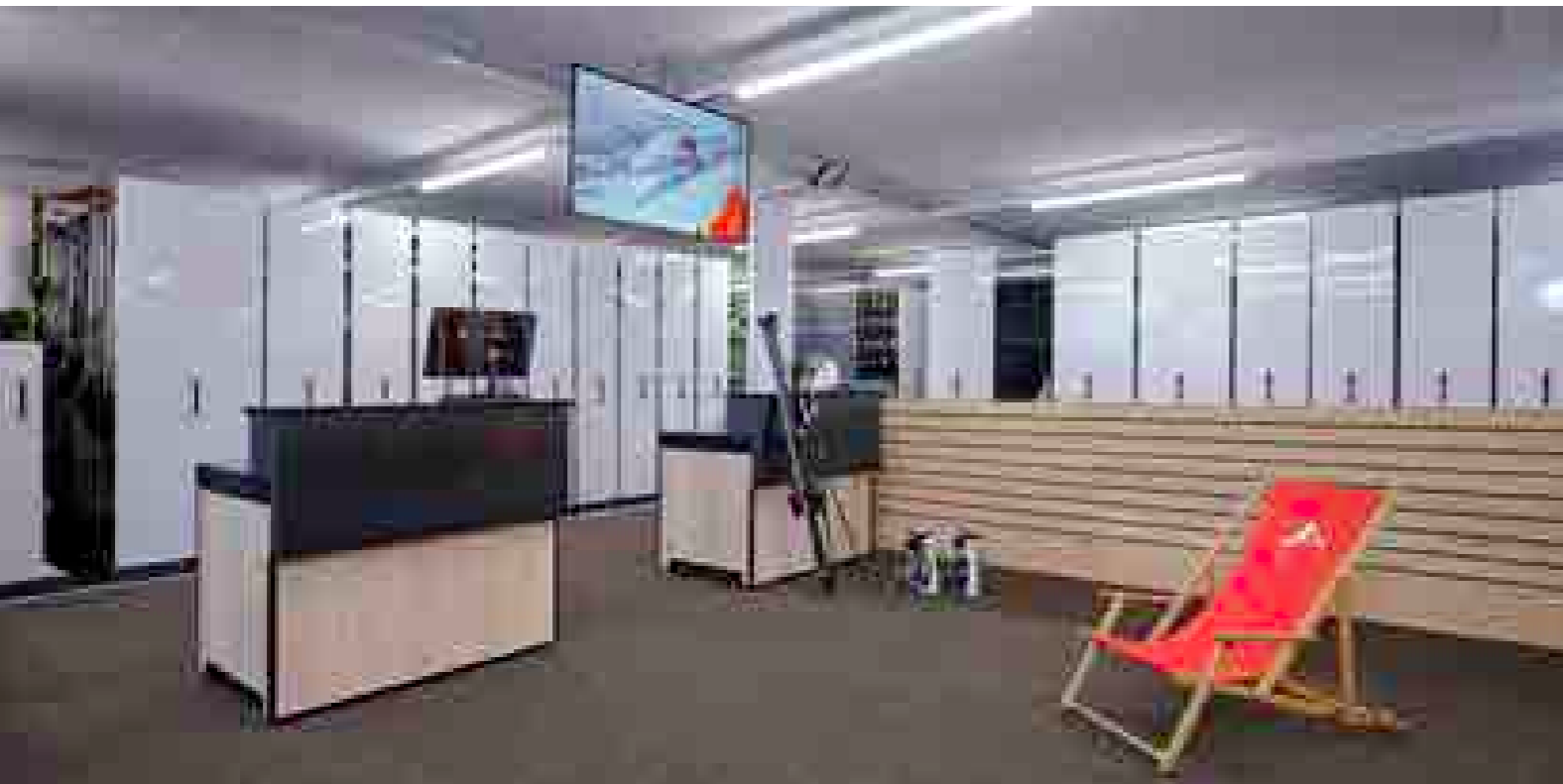

# DEPOTSYSTEME

DEPOT SYSTEMS / SYSTÈMES DE DÉPÔT / SISTEMI DI DEPOSITO



# SKICLICKE™



## SKIBINDUNGEN GANZ LEICHT ANPASSEN

ADJUSTING SKI BINDINGS MADE EASY  
LES FIXATIONS DE SKI S'AJUSTENT TRÈS FACILEMENT  
REGOLAZIONE DAVVERO SEMPLICE DEGLI ATTACCHI DEGLI SCI



BLAM ME



# BOOT BIB™



## DIE SKISCHUH ANZIEH-HILFE

THE SHOE HORN FOR SKI BOOTS  
CHAUSSE-PIED POUR CHAUSSURES DE SKI  
IL CALZASCARPONE DA SCI



BLAM ME

Eigenes Logo auf Anfrage  
Your logo on request  
Votre logo sur demande  
Logo personale su richiesta



### ABSCANNEN

SKICLICKE™ SOLE ersetzt die Skistiefel bei der Bindungsanpassung. Scannen Sie einfach den ausgewählten Skischuh ab.

### SCANNING

SKICLICKE™ SOLE replaces ski boots when sizing bindings. Simply scan the selected ski boot.

### SCANNER

SKICLICKE™ SOLE remplace la chaussure de ski lors du réglage des fixations. Scannez simplement la chaussure de ski sélectionnée.

### SCANSIONE

SKICLICKE™ SOLE sostituisce gli scarponi da sci durante la regolazione degli attacchi. Basta scansionare lo scarpone da sci selezionato.

### ABFRAGEN

Hier finden Sie die exakte Sohlenlänge, die Sie anschließend millimetergenau am SKICLICKE™ SOLE einstellen können.

### SEARCH

Here you will find the exact sole length, which you can then adjust to the millimetre on the SKICLICKE™ SOLE.

### REQUÊTE

Vous trouverez ici la longueur de semelle exacte que vous pourrez ensuite adapter au millimètre près sur le SKICLICKE™ SOLE.

### RICERCA

Qui troverete l'esatta lunghezza della suola che poi potrete regolare alla SKICLICKE™ SOLE con una precisione millimetrica.

### ANPASSEN

Abschließend führen Sie mit dem SKICLICKE™ SOLE die Voreinstellung der alpinen Bindung durch.

### ADJUST

Then use SKICLICKE™ SOLE to preset you alpine binding.

### AJUSTER

Effectuez ensuite avec SKICLICKE™ SOLE le pré-réglage les fixations alpines.

### REGOLAZIONE

Infine eseguite la prima regolazione dell'attacco dello sci con SKICLICKE™ SOLE.

### DIE SKISCHUH ANZIEH-HILFE

Mit BOOT BIB wird das Anziehen der Skistiefel zum reinsten Vergnügen. Besser kann der Einstieg ins Skivergnügen nicht sein.

### THE SHOE HORN FOR SKI BOOTS

BOOT BIB makes putting on ski boots a pure delight. Getting into your skiing adventure doesn't get any better.

### CHAUSSE-PIED POUR CHAUSSURES DE SKI

Avec BOOT BIB, enfile les chaussures de ski devient un véritable plaisir. Idéal pour commencer la journée de ski.

### IL CALZASCARPONE DA SCI

Con BOOT BIB indossare lo scarpone da sci sarà un puro divertimento. Niente di meglio per iniziare a divertirsi con gli sci.

### SO LEICHT GING'S NOCH NIE

Der BOOT BIB verringert die Reibung zwischen Socken und dem Innenschuh des Skistiefels und sorgt so für einen seidigen Einstieg.

### IT'S NEVER BEEN THIS EASY

BOOT BIB reduces friction between socks and the ski boot liner and ensures a silky entry.

### IL N'EXISTE PAS PLUS SIMPLE

BOOT BIB réduit le frottement entre la chaussette et l'intérieur de la chaussure de ski, pour une manoeuvre tout en douceur.

### NON È MAI STATO COSÌ FACILE

Il prodotto BOOT BIB riduce lo sfregamento tra le calze e l'interno dello scarpone da sci, assicurando così che scivoli via senza intoppi.

### EINFACH FÜR ALLE

BOOT BIB gibt es in zwei Versionen: Eine Große für Erwachsenen-Skistiefel und eine Kleinere für die der jüngeren Skifahrer.

### SIMPLY FOR ALL

BOOT BIB is available in two styles: A large one for adult ski boots and a small one for younger skiers.

### SIMPLE POUR TOUS

modèles BOOT BIB existent en deux versions: une taille pour les chaussures de ski adulte et une taille plus petite pour les jeunes skieurs.

### SEMPLICEMENTE PER TUTTI

Sono disponibili due versioni di BOOT BIB: una misura per gli scarponi da sci per adulti e una più piccola per gli sciatori più piccoli.

# VOLVR

the innovative loading system



## VOLVR LOADING SYSTEM

DER FORTSCHRITT IN DER AUTOMATION / THE FUTURE OF AUTOMATION  
DES PROGRÈS DANS L'AUTOMATISATION / IL PROGRESSO NELL'AUTOMAZIONE



### REVOLUTION IN AUTOMATION

Mit VOLVR, dem automatisierten Beladesystem für Ihren MONTANA Skiservice-Roboter setzt MONTANA einen neuen Meilenstein. VOLVR ist ein Volumenwunder mit einer Kapazität von unglaublichen 20 Paar Ski! Das robuste System ist kompatibel für Ski mit einer Länge von 100 cm - 200 cm und allen gängigen Alpin- und Pin Bindungen.

MONTANA is setting a new standard with VOLVR, the automated loading system for your MONTANA ski service robot. Its capacity is the stuff of miracles: it can hold an incredible 20 pairs of skis! This hard-wearing system is compatible with skis measuring 100 cm - 200 cm and with all common alpine and pin bindings.

Avec VOLVR, le système de recharge automatisé pour vos robots de ski MONTANA, MONTANA marque un nouveau tournant. VOLVR est un miracle en termes de volume avec une capacité de 20 paires de skis extraordinaires ! Ce système robuste est compatible pour des skis d'une longueur de 100 cm - 200 cm et toutes les fixations de ski alpin. Que vous soyez amateur confirmé ou débutant, professionnel de ski - VOLVR est à vos côtés.

Con VOLVR, il sistema di caricamento automatico per il robot di servizio per sci, MONTANA raggiunge una nuova pietra miliare. VOLVR è un prodigio di volume con una capacità incredibile di 20 paia di sci! Il robusto sistema è compatibile con sci di lunghezza compresa tra 100 e 200 cm e con tutti i comuni attacchi da sci-alpinismo e a pin. Per sciatori grandi e piccoli, dilettanti e professionisti, VOLVR è un valido supporto.

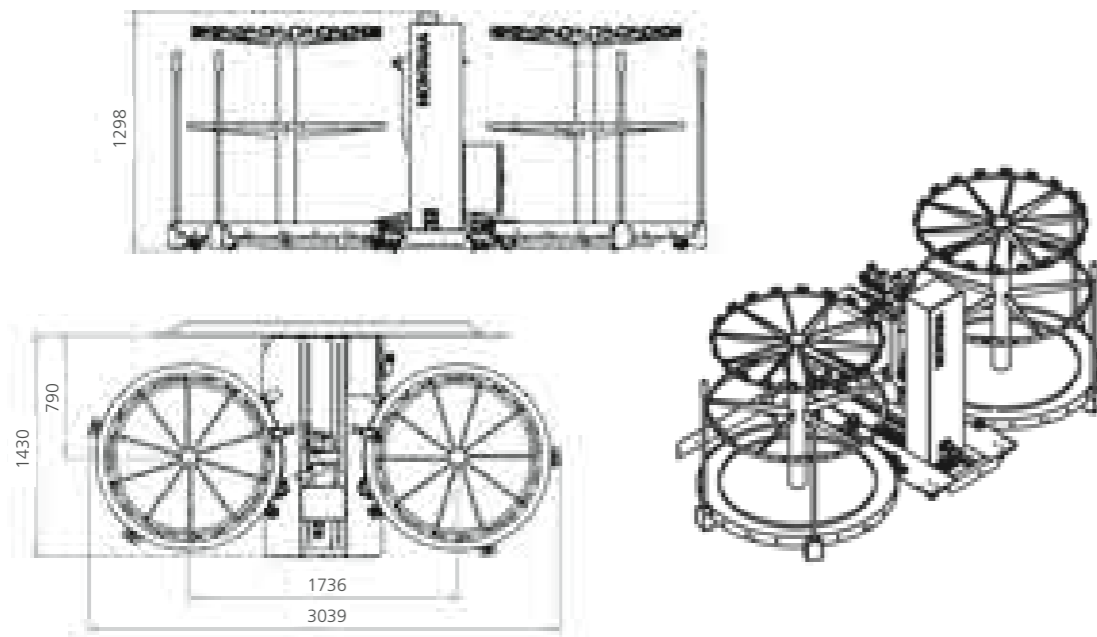

## WELCOME TO THE FUTURE

INNOVATIV, EFFICIENT & REVOLUTIONÄR / INNOVATIVE, EFFICIENT & REVOLUTIONARY  
INNOVANT, EFFICACE ET RÉVOLUTIONNAIRE / INNOVATIVO, EFFICIENTE E RIVOLUZIONARIO



# MONTANA GRIPTECH – DIE REVOLUTION IN DER PRÄPARATION DER SEITENKANTE

THE REVOLUTION IN SIDE EDGE PREPARING | UNE RÉVOLUTION DANS LA PRÉPARATION DES CARRES | LA RIVOLUZIONE NELLA PREPARAZIONE DELLA LAMINE



**GRIP**  
tech.

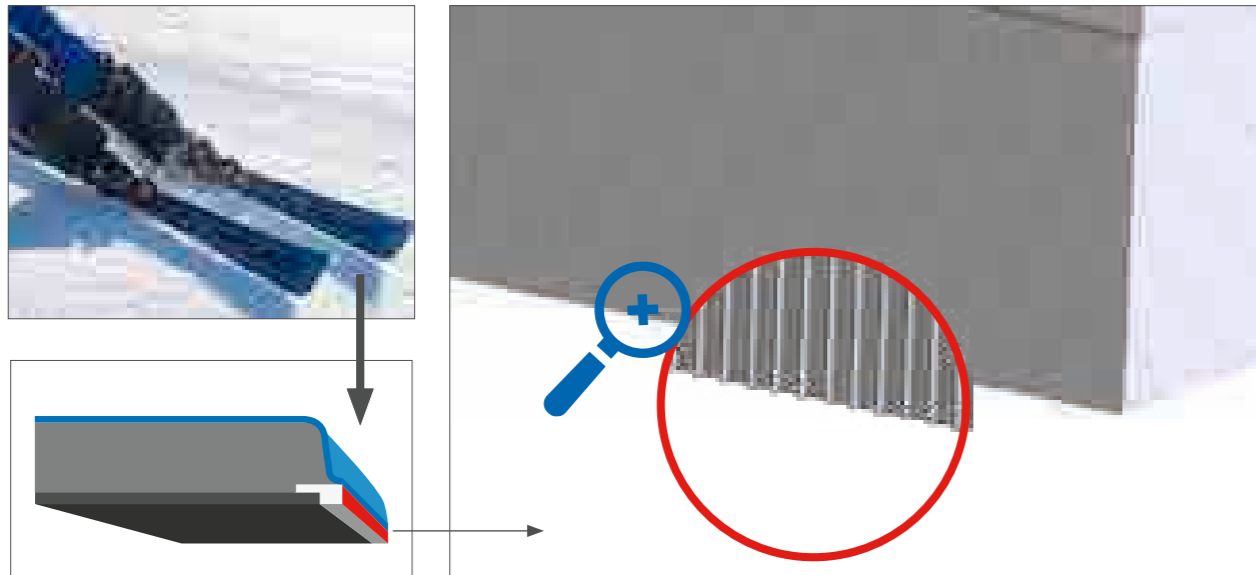

Griffige Kante

Strong edge grip | Carres antidérapantes | Lamina antisdrucchiolo

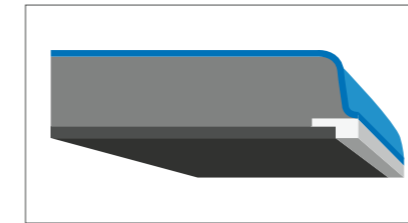

Winkel 87°-89° in 0,5° Schritten möglich

Angles 87°-89° possible in 0.5° steps | Possibilité de réglage de l'angle de 87°-89° par palier de 0,5° | Possibile angolatura tra 87°-89° a intervalli di 0,5°

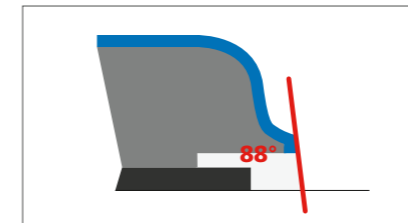

Perfekte Oberfläche

Perfect surface | Surface parfaite | Superficie perfetta



## VORTEILE

- Exakter und gleichmässiger Winkel
- Hervorragende Oberfläche in RACE EDGE Qualität
- Schleifen aller Funktionspunkte von der Schaufel bis zum Skiende
- Höchste Standzeit der Schärfe
- Materialschonender Abtrag
- Höchster Durchsatz bei konstanter Qualität
- Schleift selbst korrodierte Kanten hervorragend
- Hohe Wirtschaftlichkeit
- Für Ski und Snowboard
- Maximale Fahrfreude

## ADVANTAGES

- Precise and steady angle
- Outstanding RACE EDGE quality surface
- Grinds all functional areas from shovel to tail
- Longest lasting sharpness
- Grinding is gentle on the material
- Maximum output with consistent quality
- Excellent results even on corroded edges
- High cost efficiency
- For skis and snowboards
- Ultimate skiing and snowboarding pleasure

## AVANTAGES

- Angle précis et régulier
- Surface d'excellence de qualité RACE EDGE
- Affûtage de tous les points fonctionnels, de la spatule au talon
- Longévité maximale du tranchant
- Usure faible préservant les matériaux
- Débit d'utilisation poussé au maximum, avec une qualité constante
- Parvient même à affûter les carres corrodées avec excellence
- Rentabilité élevée
- Pour les skis et snowboards
- Un plaisir de glisse maximal

## VANTAGGI

- Angolatura esatta ed omogenea
- Superficie eccezionale con qualità RACE EDGE
- Rettifica di tutti i punti funzionali dalla spatola alla coda
- Elevata durata dell'affilatura
- Abrasione delicata del materiale
- Massimo rendimento a qualità costante
- Rettifica in modo eccezionale le lamine che si sono corrose
- Elevata efficienza
- Per sci e snowboard
- Massima piacevolezza mentre si scia

## BELAGSREPARATUR

BASE REPAIR / RÉPARATION DES REVÊTEMENTS / RIPARAZIONE DELLE SUPERFICI



### P-TEX – AUFSCHEMELZDRAHT

Wire / Fil de surmoulage / Filo di formatura

3 mm x 70 m (MONTY Extruder)

101963 transparent / clear / transparent / trasparente

101964 schwarz / black / noir / nero

3 mm x 260 m (P-Tex MASTER, P-Tex SPEEDMASTER)

101961 transparent / clear / transparent / trasparente

101962 schwarz / black / noir / nero

5 mm x 200 m (MRS 2000 + GSA 2000)

101965 transparent / clear / transparent / trasparente

101966 schwarz / black / noir / nero

### COPOLYMER – REPARATURDRAHT

Repair wire / Fil de réparation / Filo per riparazioni

3 mm x 10 m

Haftbrücke zwischen Kante und Belag. Gute Haftung auf Metallteilen.

Bonding course between edge and base. Good adhesion on metal parts.

Pont d'adhérence entre les carres et la semelle. Bonne adhérence sur les parties métalliques.

Ponte adesivo fra lamina e soletta. Buona aderenza sui metalli.

101957 transparent / clear / transparent / trasparente

105485 schwarz / black / noir / nero



### LAFIX – REPARATURKERZEN

Repair candles / Bougies de réparation / Candele per riparazioni

10 x 20 g

101951 transparent / clear / transparent / trasparente

101952 schwarz / black / noir / nero



### P-TEX 2000 – BELAGSMATERIAL

Base material / Matériel de base / Materiale di soletta

gesintert / sintered / frittés / sinterizzato

1.3 mm x 110 mm x 1 m

101968 transparent / clear / transparent / trasparente

101967 schwarz / black / noir / nero



### LAFIX – REPARATURSTREIFEN

Repair strips / Bandes de réparation / Strisce per riparazioni

1 kg für / for / pour / per: Hot Jet

107038 transparent / clear / transparent / trasparente

107039 schwarz / black / noir / nero



### MONTY EXTRUDER

MONTANA Monty Extruder

Das Profi-Handgerät für Belagsreparaturen

The professional handheld device for base repairs

L'appareil manuel des professionnels pour les réparations de la semelle

Il dispositivo manuale professionale per le riparazioni della soletta

105643 230 V



### NACHRÜSTUNG ABSAUGUNG MONTY EXTRUDER

Retrofitting exhaust Monty Extruder

Réadaptation aspiration Monty Extruder

Retrofitting risucchio Monty Extruder

109407 230 V

109412 Haube & Schlauch zur Absaugung, Cover and tube for suction  
Capot & tuyau d'aspiration, Calotta e tubo flessibile per aspirare

109684 Schlauch / Schlauch / Schlauch / Schlauch

108515 Schutz Korb / Schutz Korb / Schutz Korb / Schutz Korb



### ERSATZFILTER SET ABSAUGUNG MONTY EXTRUDER

Replacement filter set for extraction Monty Extruder

Set de filtres de rechange pour l'extraction Monty Extruder

Set di filtri di ricambio per l'aspirazione Monty Extruder

1 mal Hauptfilter / 5 mal Vorfilter

109416 230 V

### REPARATURPISTOLE V MONTANA

Repair gun V / Pistolet de réparation V / Pistola per riparazioni V

200375 220 ~ 240 V



### LAFIX – REPARATURSTIFTE

Repair sticks / Bâtonnets de réparation / Candele di riparazione

11.5 mm à 10 Stück / pieces / pièces / pezzi

für Reparaturpistole / for repair gun / pour pistolet de réparation per la pistola

101953 transparent / clear / transparent / trasparente

101954 schwarz / black / noir / nero



## BELAGSREPARATUR

BASE REPAIR / RÉPARATION DES REVÊTEMENTS / RIPARAZIONE DELLE SUPERFICI



### HOT JET – SET HEISSLUFT-REPARATURGERÄT INKL. AUFSCHELMZKOPF

Hot air blower and nozzle set

Set à air chaud de réparation avec buse

Set attrezzo per riparazioni ad aria calda con testina di formatura

20° – 600° C

stufenlos regulierbar / fully adjustable / réglable en continu / a regolazione in continuo

\*200233 230V / 460W

A



### HOT JET – HEISSLUFT-REPARATURGERÄT EXKL. AUFSCHELMZKOPF

Repair hot air blower excl. nozzle

Séchoir de réparation sans buse

Set attrezzo per riparazioni ad aria calda senza testina di formatura

20° – 600° C

stufenlos regulierbar / fully adjustable / réglable en continu / a regolazione in continuo

\*200231 230 V / 460 W



### HOT JET – AUFSCHELMZKOPF II (KOMPLETT)

Nozzle II (complete) / Buse II (complet) / Testina di formatura II (completa)

\*108248



### HOT JET – AUFSCHELMZPLATTE KUPFER

Fusing plate copper / Plaque surmoulage cuivre / Piastra di formatura rame

\*108249 42 x 38 x 2 mm



### LAFIX – REPARATURSTREIFEN

Repair strips / Bandes de réparation / Strisce per riparazioni

1 kg für / for / pour / per: Hot Jet

107038 transparent / clear / transparent / trasparente

107039 schwarz / black / noir / nero



# BELAGSREPARATUR

BASE REPAIR / RÉPARATION DES REVÊTEMENTS / RIPARAZIONE DELLE SUPERFICI



STANZ-SET FÜR SKI- UND SNOWBOARD-BELAGSREPARATUR	
Punch set for ski and snowboard base repair	
Set d'outils à empiècements pour la réparation des skis et snowboards	
Set attrezzi di punzonatura per la riparazione delle superfici di sci e snowboard	
Koffer / case / valise / valigetta	
*5000	
3x Stanzwerkzeuge / punching tools / outils de découpage / punzoni (5020 / 5030 / 5010)	
1x Elektro-Heizplatte / heating plate / plaque chauffante / piastra termo-elettrica (5080)	
1x Schraubzwinde / screw clamp / serre-joint / morsa a vite (5085)	
1x Trennpapier / anti-adhesive paper / papier de séparation / carta antiadesiva (5100)	
2x Streifen P-Tex Belag, schwarz + weiss / strips of P-Tex base material black + white / bandes de revêtement P-Tex-, noir + blanc / strisce P-Tex soletta, nero + bianco (9.5 x 50 cm)	

ELEKTRO-HEIZPLATTE	
Heating plate / Plaque chauffante / Piastra termo-elettrica	
*5080	230 V

WÄRME-LEITBLECH	
Heat guiding plate / Tôle déflecteur de chaleur / Piastra a conduzione termica	
*5082	gebogen / curved / arqué / arcuata

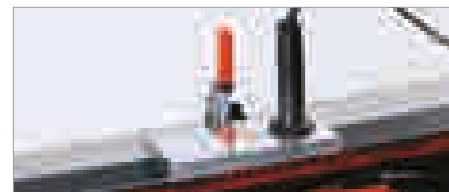

Vorwärmen des Belages  
Pre-heating the base  
Préchauffage du revêtement  
Pre-riscaldamento della base

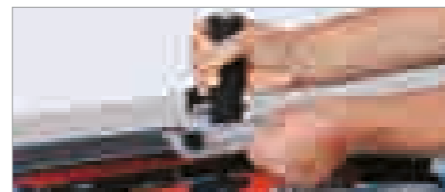

Einstellen des Abstandes zur Seitenkante / Adjusting the distance to the steel edge / Réglez la distance par rapport à la carre / Impostazione della distanza dal lamina laterale

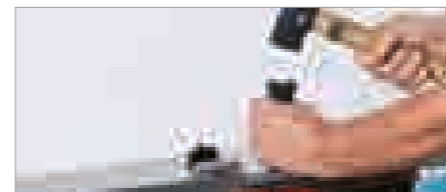

Ausstanzen des beschädigten Belages  
Punching out the damaged base area  
Découpez le revêtement endommagé  
Rimozione della superficie danneggiata

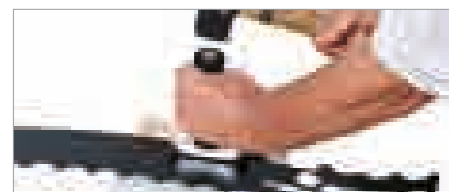

Ausstanzen des Reparaturbelages  
Punching out the patching material  
Découpez le matériel de réparation  
Punzonatura della superficie di riparazione



Einkleben mittels Heizplatte und Trennpapier / Glu-in by means of heating plate and anti-adhesive paper / Collez en vous servant de la plaque chauffante et du papier de séparation / Incollaggio tramite piastra termo-elettrica e carta anti-adesiva



Stanzprofile in verschiedenen Grössen  
Various patching profiles available  
Différentes formes de découpage  
Profili di punzonatura in diverse grandezze

STANZWERKZEUGE	
Punching tools / Outils de découpage / Attrezzi di punzonatura	
mit auswechselbaren Stanzmessern / with replaceable blades / avec des lames remplaçables / con lame intercambiabili	

48 X 21 mm	
halbrund / semi circle / semi-circulaire / semicircolare	
*5020	Stanzwerkzeug / punching tool / outil de découpage / punzone
*5060	Stanzmesser / blade / lame / lama

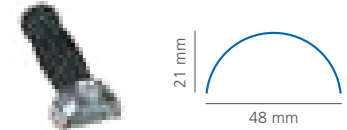

41 X 12 mm	
oval offen / oval open / oval ouvert / ovale aperto	
*5030	Stanzwerkzeug / punching tool / outil de découpage / punzone
*5070	Stanzmesser / blade / lame / lama

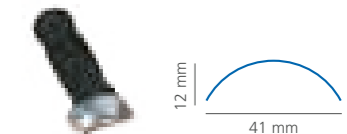

70 X 15 mm	
rechteckig gerundet offen klein / rectangular open rounded small / rectangulaire arrondi ouvert petit / rettangolare smussato aperto piccolo	
*5036	Stanzwerkzeug / punching tool / outil de découpage / punzone
*5076	Stanzmesser / blade / lame / lama



100 X 25 mm	
rechteckig gerundet offen gross / rectangular open rounded big / rectangulaire arrondi ouvert grand / rettangolare smussato aperto grande	
*5033	Stanzwerkzeug / punching tool / outil de découpage / punzone
*5073	Stanzmesser / blade / lame / lama



30 X 30 mm	
rund gross / round large / rond grand / tondo grande	
*5031	Stanzwerkzeug / punching tool / outil de découpage / punzone
*5071	Stanzmesser / blade / lame / lama

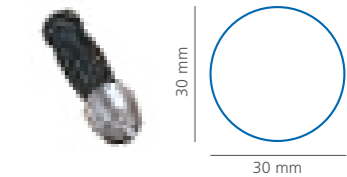

# BELAGSREPARATUR

BASE REPAIR / RÉPARATION DES REVÊTEMENTS / RIPARAZIONE DELLE SUPERFICI

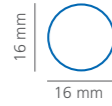

## 16 X 16 mm

rund klein / round small / rond petit / tondo piccolo

\*5034 Stanzwerkzeug / punching tool / outil de découpage / punzone

\*5074 Stanzmesser / blade / lame / lama



## 60 X 10 mm

rechteckig / rectangular / rectangulaire / rettangolare

\*5010 Stanzwerkzeug / punching tool / outil de découpage / punzone

\*5040 Stanzmesser / blade / lame / lama



## 70 X 15 mm

rechteckig gerundet klein / rectangular rounded small  
rectangulaire arondi petit  
rettangolare smussato piccolo

\*5035 Stanzwerkzeug / punching tool / outil de découpage / punzone

\*5075 Stanzmesser / blade / lame / lama



## 100 X 27 mm

rechteckig gerundet gross / rectangular rounded large  
rectangulaire arondi grand  
rettangolare smussato grande

\*5032 Stanzwerkzeug / punching tool / outil de découpage / punzone

\*5072 Stanzmesser / blade / lame / lama

## STANZ-PLATTE

Punching-pad / Plaque d'appui pour découpage / Tappetino d'appoggio per punzonatura

\*5500 200 x 150 x 25 mm



## SCHRAUBZWINGE

Screw clamp / Serre-joint / Morsa a vite

\*5085 105 mm



## TRENNPAPIER

Anti-adhesive paper / Papier de séparation / Carta anti-adesiva

\*5100 10 cm x 500 cm



## SCHABER ERGO MIT KNAUF

Scraper Ergo with handle / Grattoir Ergo avec pommeau / Raschiatore Ergo con manico

Klingenbreite 65 mm

Blade width 65 mm

Largeur de la lame 65 mm

Larghezza della lama 65 mm

\*107028 Schaber / scraper / grattoir / raschiatore

\*107029 Ersatzklinge / replacement blade

lame de remplacement / lama di ricambio



## ABRICHTWERKZEUGE

DRESSING TOOLS / OUTILS DE DRESSAGE / ATTREZZI DI RETTIFICA



### K 125 LF

für Steine / for stones / pour meules / per mole: 115 – 160 mm

107681

A



### K 320 LF

für Steine / for stones / pour meules / per mole: 320 – 340 mm

107538

### STRUCTUR SPEEDCUT

#### MONTANA Structur Speedcut

spezieller Struktur-Diamant  
special diamond for structures  
diamant spécial pour structures  
diamante speciale per impronte

109404 PW-V 5885 RZ / 7 LF

A

107540 PW-V 575557 LF

107683 K 460 LF

A

110849 PW-K4445RZ LF

CC RACE

110408 K 320 / 05



### PW-V 1555 LF

für / for / pour / per HTT-Tuning

107682



### PW-V 1885 RM

für / for / pour / per HTT PRO-Tuning

109436

### ABRICHTKNOPF

Dressing unit

Outil de dressage

Bottone di rettifica

für Polierscheiben

for polishing discs

pour disques de polissage

per dischi di lucidatura

101873



### ABRICHTSYSTEM PLEXI

Plexi blocks

Dresseur système en plexi

Sistema di rettifica plexi

mit Grundplatte / with base plate / avec plaque de base / con piastra di base

108519 160 mm

108520 180 mm

108521 200 mm

107598 320 mm

ohne Grundplatte / without base plate / sans plaque de base / senza piastra di base

108522 160 mm

108523 180 mm

108524 200 mm

107599 320 mm

110810 180 mm CC RACE

110811 1 x 80mm CC RACE

110812 2 x 80mm CC RACE

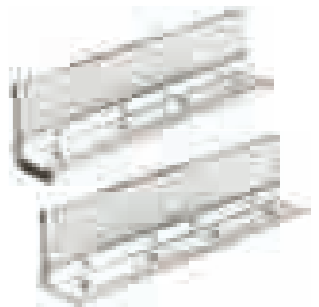

### ABRICHTSTEIN

Dressing stone

Pierre de dressage

Pietra di rettifica

für Schleif-, Tuning- und Wachsband

for grinding, tuning and waxing belt

pour bande de ponçage, tuning et fartage

per nastro abrasivo, tuning e nastro sciolinatura

102008 145 x 100 x 18 mm





## SCHLEIFSCHEIBEN FÜR TUNING-SYSTEM

GRINDING DISCS FOR TUNING SYSTEM / DISQUES DE PONÇAGE POUR LE SYSTÈME TUNING / DISCHI DI LEVIGATURA PER IL SISTEMA TUNING



TUNING-SCHEIBE BLAU/ROT			
Tuning-disc blue / red			
Disque-tuning bleu / rouge			
Disco-tuning blu / rossow			
Paar / pair / la paire / al paio			
105594	Snow Cruiser, GHHT, Modular, Saphir / Rock 230 x 50 x 152 mm	blau / blue / bleu / blu	
109524	Crystal Magic 250 x 50 x 152 mm	blau / blue / bleu / blu	
105628	Crystal Spirit, Modular Energy 300 x 50 x 152 mm	blau / blue / bleu / blu	A
105867	Challenge 200 x 46 x 80 mm / 120 x 15 mm	blau / blue / bleu / blu	
108175	Diamond 300 x 60 x 145 mm / 172 x 10 mm	blau / blue / bleu / blu	
108707	Crystal Magic / One / Race 350 x 60 x 203 mm	blau / blue / bleu / blu	
108708	Crystal One / Race / Onyx 350 x 80 x 203 mm / 232 x 10 mm	blau / blue / bleu / blu	
108709	Crystal One / Race 350 x 80 x 203 mm / 232 x 10 mm	blau / blue / bleu / blu	A
109080	Crystal Rock 230 x 50 x 152 mm	rot / red / rouge / rosso	
109078	Crystal Magic 350 x 60 x 203 mm	rot / red / rouge / rosso	
Stück / piece / pièce / al pezzo			
108986	Compact ST 90 x 25 x 12 mm / 30 x 15 mm	blau / blue / bleu / blu	

POLIER-SCHEIBE FÜR DUAL-FINISH, HTT 3D-FINISH			
Polishing-disc for dual finish, HTT 3D-Finish			
Disque de polissage pour dual finish, HTT 3D-Finish			
Disco di lucidatura per Dual-finish, HTT 3D-Finish			
Stück / piece / pièce / al pezzo			
108251	200 x 20 x 140 mm	blau / blue / bleu / blu	
108252	240 x 20 x 180 mm	blau / blue / bleu / blu	



## SCHLEIFSTEINE UND -RINGE

GRINDING STONES AND RINGS / MEULES ET DISQUES DE PONÇAGE MOLE E DISCHI DI RETTIFICA

SCHLEIFRINGE					
Grinding rings / Disques de ponçage / Anelli di rettifica					
110819	300 x 80 x 152 mm	rosa / pink / rose / rosa		A36J9*	
110820	300 x 80 x 152 mm	blau / blue / bleu / blu		A54J10E*	
105983	300 x 125 x 152 mm	braun / brown / brun / marrone	E-54 / 1 J*	A	
106454	300 x 160 x 150 mm	orange / orange / orange / arancione	A-36 / L	A	
106455	300 x 160 x 150 mm	blau / blue / bleu / blu	E-30 / 2	A	
110710	300 x 180 x 152 mm	blau / blue / bleu / blu	A36/KK28W		
101914	350 x 115 x 203 mm	blau / blue / bleu / blu	E-24 / 2	A	
101920	350 x 125 x 203 mm	braun / brown / brun / marrone	E-54 / 1 J*	A	
101919	350 x 125 x 203 mm	braun / brown / brun / marrone	E-30 / 1 / 7	A	
101912	350 x 125 x 203 mm	blau / blue / bleu / blu	E-30 / 2		
105231	350 x 135 x 203 mm	orange / orange / orange / arancione	A-36 / LB		
101923	350 x 135 x 203 mm	braun / brown / brun / marrone	E-30 / 2 / 7	A	
106181	350 x 160 x 203 mm	orange / orange / orange / arancione	A-36 / LB		
109031	350 x 160 x 203 mm	blau / blue / bleu / blu	A-36 / LL10		
106182	350 x 160 x 203 mm	braun / brown / brun / marrone	E-30 / 2 / 7		
108704	350 x 180 x 203 mm	orange / orange / orange / arancione	A-36 / LB		
108705	350 x 200 x 203 mm	orange / orange / orange / arancione	A-36 / LB		

SCHLEIFRINGE BREIT					
Grinding rings large / Disques de ponçage larges / Anelli di rettifica grandi					
109463	300 x 340 x 152 mm	blau / blue / bleu / blu		A-36/KK10P	
109313	350 x 320 x 152 mm	blau / blue / bleu / blu		A-36/KK10P	
109525	350 x 320 x 152 mm	braun / brown / brun / marrone	E-30/2/7LP		
110241	350 x 320 x 152 mm	blau / blue / bleu / blu	HKK	A36/KK28W	
110242	350 x 320 x 152 mm	weiss / white / blanc / bianco		A-30/KL350	A
110383	350 x 320 x 152 mm	rosa / pink / rose / rosa	HKK	A-30/KL350	
110241	350 x 320 x 152 mm	blau / blue / bleu / blu	HKK	A36/KK28W	
109464	350 x 340 x 152 mm	blau / blue / bleu / blu		A-36/KK10P	

(d) Ø Innerer Schleifring / inner grinding disc / meule à ponçage intérieure / pietra rettifica interna

(B) Ringbreite / disc width / largeur de la meule / larghezza della pietra

(D) Ø Äusserer Schleifring / outer grinding disc / meule à ponçage extérieure / pietra rettifica esterna

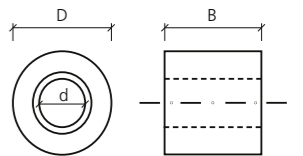
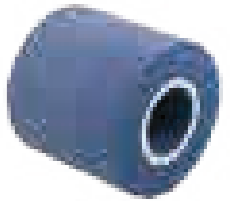

! Bei jedem Steinwechsel muss das Abrichtsystem Holz / Plexi mit gewechselt werden – ansonsten droht erhöhte Crash Gefahr!

The wood/plexiglass dressing system must be changed every time the stone is changed – otherwise there is an increased risk of a crash!

A chaque changement de pierre, le système de dressage bois / plexi doit être changé en même temps - sinon il y a un risque accru de crash !

Il sistema di pulizia in legno/plexi deve essere sostituito ogni volta che si cambia la pietra - altrimenti aumenta il rischio di caduta!

\*) für Langlauf-Ski / for cross-country skis / pour skis de fond / per sci di fondo

# MONTANA®

## WINTHERACE™

- ✓ Gifffrei & umweltfreundlich
- ✓ Geruchlos, farblos, klar
- ✓ Kein Fluorzusatz
- ✓ Multifunktional von +8°C bis -30°C
- ✓ Superhydrophob – extrem Wasserabstossend
- ✓ Imprägniert ski – schützt vor Rost und Korrosion
- ✓ Bei allen Schneearten
- ✓ Einfache und schnelle Applikation
  
- ✓ Non-toxic & environmentally friendly
- ✓ Odourless, colourless, clear
- ✓ No fluorine additive
- ✓ Multifunctional from +8°C to -30°C
- ✓ Super hydrophobic – extremely water repellent
- ✓ Impregnates ski – protects against rust and corrosion
- ✓ For all snow conditions
- ✓ Easy and fast application
  
- ✓ Non-toxique & respectueux de l'environnement
- ✓ Inodor, incolore, transparent
- ✓ Aucun additif fluoré
- ✓ Multifonctionnel de +8°C à -30°C
- ✓ Super hydrophobe – extrêmement hydrofuge
- ✓ Impregne skis – protège contre la rouille et la corrosion
- ✓ Pour tous les types de neige
- ✓ Application facile et rapide
  
- ✓ Atossico ed ecologico
- ✓ Inodore, incolore, trasparente
- ✓ Senza fluoruro
- ✓ Versatile da +8°C a -30°C
- ✓ Superidrofobico – estremamente idrorepellente
- ✓ Impregna gli sci, proteggendoli dalla ruggine e dalla corrosione
- ✓ Per tutti i tipi di neve
- ✓ Semplice e rapido da applicare



**COVERN – DIE INTELLIGENTE ALTERNATIVE ZUM WACHSEN!**

PERFEKT FÜR SKI, LANGLAUF & SNOWBOARDS!

**COVERING – THE INTELLIGENT ALTERNATIVE TO WAXING!**

PERFECT FOR ALPINE + XC SKIS + SNOWBOARDS!

**COVERING – L'ALTERNATIVE INTELLIGENTE AU LIEU DE FARTAGE!**

PARFAIT POUR SKIS, SKIS DE FONDS ET SNOWBOARDS!

**COVERING – L'ALTERNATIVA INTELLIGENTE ALLA SCIOLINATURA!**

PERFETTO PER SCI, SCI DI FONDO + SNOWBOARDS!

## HIGH CLASS RACE SERVICE

THE UNIQUE SIDE EDGE FINISH FOR YOUR RACE ADDICTED CLIENTS



<b>TOPFSCHLEIBE</b>		
Disc / Disque / Disco		
109023	80 Korn / disc / grains / grana ohne Schleifscheiben-Dorn / without disc mandrel sans mandrin / senza mandrino	
*109028	Schleifscheiben-Dorn / disc mandrel mandrin de disque / mandrino per disco Stahl / steel / acier / acciaio für Topfschleibe / einmalige Anschaffung, wiederverwendbar for disc / one-time acquisition, reusable pour disque / achat unique, réutilisable per disco / acquisto unico, riutilizzabile	

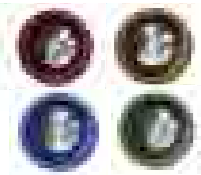

107533	120 Korn / grit / grains / grana / rot / red / rouge / rosso	
107534	240 Korn / grit / grains / grana / gelb / yellow / jaune / gialla	
107535	320 Korn / grit / grains / grana / blau / blue / bleu / blu	
107536	500 Korn / grit / grains / grana / grün / green / vert / verde	A

<b>ANSCHLAGWINKEL MIT ABSAUGSTUTZEN</b>		
Angle stop with suction nozzle		
Equerre d'angle avec une prise d'aspiration		
Angolo di arresto con un raccordo di aspirazione		
109311	86 °	A



<b>SEITENWANGENHOBEL INKL. KLINGE RUND</b>		
Sidewall sharpener with round blade		
Outil pour champs avec lame arrondie		
Toglifenolo con lama arrotondata		
107779		A



<b>ERSATZKLINGEN</b>		
Spare blade / Lame de rechange / Lama di ricambio		
107782	Standard	A
107780	Rund / round / arrondie / tonda	A



## SEITENKANTEN-SCHLEIFBÄNDER

SIDE EDGE SANDING BELTS / BANDES DE PONÇAGE POUR CARRES LATÉRALES  
NASTRI ABRASIVI PER LAMINE LATERALI

<b>20 X 1100 MM</b>		
SNOWBOARD LC / MONTY BELT, COMPACT 2000		
101825	Korn / grit / grains / grana: 80	
101826	Korn / grit / grains / grana: 100	



<b>30 X 623 MM</b>		
COMPACT, 3-D FINISH, M2000, M 2000 Combi, MC 2000		
101827	Korn / grit / grains / grana: 80	
101828	Korn / grit / grains / grana: 100	

<b>30 X 910 MM</b>		
SNOW CHALLENGE, MODULAR 4, MSG 2000, CARVER (GHIT 2000), MAS 2000 GSW HTT		
101830	Korn / grit / grains / grana: 80	
101831	Korn / grit / grains / grana: 100	
106264	Korn / grit / grains / grana: 120	

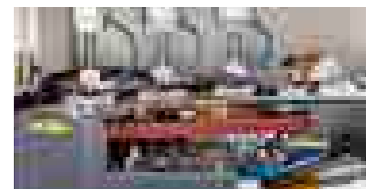

<b>30 X 1340 MM</b>		
CRYSTAL DIAMOND, MODULAR ENERGY, SNOW CRUISER, MCS 2000, KSM MONTY, SAPHIR		
101833	Korn / grit / grains / grana: 80	
101834	Korn / grit / grains / grana: 100	
101835	Korn / grit / grains / grana: 120	

## SEITENKANTEN-SCHLEIFBÄNDER

SIDE EDGE SANDING BELTS / BANDES DE PONÇAGE POUR  
CARRES LATÉRALES / NASTRI ABRASIVI PER LAMINE LATERALI

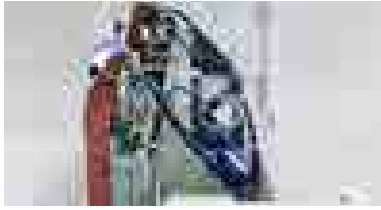

### 50 X 1340 MM GRIPTECH

#### CRYSTAL MAGIC, ONYX, ROCK, ONE

109413	Korn / grit / grains / grana:	240	
109414	Korn / grit / grains / grana:	320	
110312	Korn / grit / grains / grana:	600	
109545	Korn / grit / grains / grana:	150 CU II	A
109546	Korn / grit / grains / grana:	180 CU II	
109570	Trizact	A 65	A
109569	Trizact	A100	A

### 30 X 1500 MM

#### DSG 2000

101837	Korn / grit / grains / grana:	80
101838	Korn / grit / grains / grana:	100

Andere Dimensionen sämtlicher Bänder auf Anfrage.  
Other dimensions for all kinds of sanding belts can be ordered.  
Autres dimensions pour toute les bandes de ponçage sur demande.  
Su richiesta, sono disponibili misure diverse per tutti i nastri.

### Selbstschärfende high-tech CERAMIC Schleifbänder

Im Keramik Korn sind feine Aluminiumoxid-Kristalle (Al<sub>2</sub>O<sub>3</sub>) durch einen Sinterungsprozess miteinander verbunden. Diese Mikrokristalle brechen während des Schleifprozesses heraus, sodass das Schleifkorn immer neue, scharfe Schneidkanten erhält.

### Self-sharpening high-tech CERAMIC sanding belts

The ceramic grains consist of fine aluminium oxide crystals (Al<sub>2</sub>O<sub>3</sub>) produced in a sintering process. These micro-crystals break continuously during grinding so that new grain-cutting edges are created.

### Bandes de ponçage auto-affûtées CERAMIC high tech

Les grains de céramique sont constitués de fins cristaux d'oxyde d'aluminium produits par sinterisation. Ces microcristaux se cassent continuellement pendant le ponçage afin de créer de nouvelles pointes de coupe de grain.

### Nastri abrasivi autoaffilanti high-tech CERAMIC

Nella grana di ceramica vi sono finissimi cristalli in ossido di alluminio (Al<sub>2</sub>O<sub>3</sub>), legati fra loro tramite sinterizzazione, in modo che la grana abrasiva abbia sempre nuovi bordi affilati.

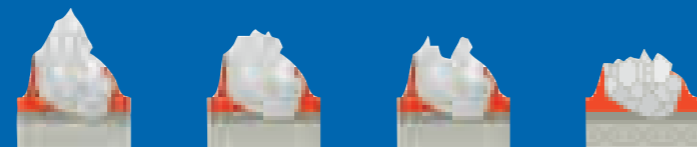

Schleifzeit / Grinding time / temps de ponçage / tempo per la rettifica

## SCHLEIFBÄNDER UND ZUBEHÖR

SANDING BELTS AND ACCESSORIES / BANDES DE PONÇAGE  
ET ACCESSOIRES / NASTRI ABRASIVI ED ACCESSORI

### VOLLKERAMIK-GLEITSCHUHE

#### Full ceramic sliding block / Sabot d'affûtage céramique / Pattini in ceramica

für Seitenkanten-Aggregate / for side edge grinding units

pour unités d'affûtage des carres latérales / per unità di affilatura bordi laterali: MONTANA

109480	0°	vertikal Band <b>GRIPtech</b> / vertical belt bande verticale / nastro verticale
101884	0°	
101885	1°	
101886	2°	
101887	3°	
105951	4°	

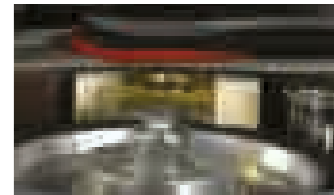

### 150 X 1500 MM

#### M 2000, GMU 2000

Schleifbänder / Sanding belts / Bandes pour le ponçage / Nastri abrasivi

#### Korn / grit / grains / grana:

101840		blau / blue / bleu / blu	80
101841		blau / blue / bleu / blu	100
101842		blau / blue / bleu / blu	120
106219	Tuning	rot / red / rouge / rosso	80
105742	Trizact	braun / brown / brun / marrone	100
107191	Trizact	blau / blue / bleu / blu	100



### 345 X 1615 MM

#### SNOWBOARD LC, MONTY BELT, CRYSTAL INLINE

Tuningbänder / Tuning belts / Bandes pour le tuning / Nastri tuning

#### Korn / grit / grains / grana:

101856		blau / blue / bleu / blu	80
101857		blau / blue / bleu / blu	100
101858		blau / blue / bleu / blu	120
106220	Tuning	rot / red / rouge / rosso	80
109984	CU II	rot / red / rouge / rosso	80
109985	CU II	rot / red / rouge / rosso	120
105743	Diamant Trizact	braun / brown / brun / marrone	100
107192	Trizact	blau / blue / bleu / blu	100



### 400 X 1012 MM

#### SNOWBOARD UNIVERSAL 2

#### Korn / grit / grains / grana:

101848		blau / blue / bleu / blu	80
101849		blau / blue / bleu / blu	100



## WACHSEN, POLIEREN UND ZUBEHÖR

WAXING, POLISHING AND ACCESSORIES / FARTAGE, POLISSAGE ET ACCESSOIRES  
SCIOLINATURA, LUCIDATURA ED ACCESSORI

### WACHSEN UND POLIEREN

Waxing and polishing / Polissage et fartage / Sciolinatura e lucidatura

gelb / yellow / jaune / giallo

105228	150 x 1500 mm	M 2000, GMU 2000
105229	345 x 1615 mm	SNOWBOARD LC, MONTY BELT, CRYSTAL INLINE

### MSG – WACHSEN UND POLIEREN

Waxing and polishing / Polissage et fartage / Sciolinatura e lucidatura

schwarz / black / noir / nero

101810	150 x 1500 mm	M 2000, GMU 2000	
101814	345 x 1615 mm	SNOWBOARD LC, MONTY BELT, CRYSTAL INLINE	
101812	400 x 1013 mm	SNOWBOARD UNIVERSAL 2	
101815	355 x 2050 mm	SNOWRIDER	A

### WACHSEN UND ENTGRATEN

Waxing and deburring / Fartage et ébavurage / Sciolinatura e sbavatura

petrol / petrol / bleu pétrole / petrolio

101809	150 x 1500 mm	M 2000, GMU 2000
101808	345 x 1615 mm	SNOWBOARD LC, MONTY BELT, CRYSTAL INLINE

### REINIGUNGSGUMMI

Reinigungsgummi für Polier- und Wachsrollen sowie Wachsbänder

Cleaner for polishing and waxing rolls and for waxing belts

Gomme nettoyant pour rouleaux et bandes de polissage et fartage

Gomma pulente per rulli di lucidatura e nastri per sciolinatura

104939

### WACHSROLLE

Waxing roll / Rouleau de fartage / Rullo per sciolinatura

104889	MODULAR ENERGY, DIAMOND	A
106337	SAPHIR, CHALLENGE MAX W <i>Bohrung 76 mm / Borehole 76 mm / perçage 76 mm / foro 76 mm</i>	
102110	WAXMASTER	
107662	WAXMASTER II <i>Bohrung 96 mm / Borehole 96 mm / perçage 96 mm / foro 96 mm</i>	MAGIC, ROCK MAX W
109439	ONYX	

### POLIERROLLE

Polishing roll / Rouleau de polissage / Rullo per lucidatura

104890	MODULAR ENERGY, DIAMOND	A
106336	SAPHIR, CHALLENGE MAX W <i>Bohrung 76 mm / Borehole 76 mm / perçage 76 mm / foro 76 mm</i>	
102109	WAXMASTER	
107817	WAXMASTER II <i>Bohrung 96 mm / Borehole 96 mm / perçage 96 mm / foro 96 mm</i>	MAGIC, ROCK MAX W
109440	ONYX	
2760	NYLONBÜRSTE / NYLON BRUSH BROSSE EN NYLON / SPAZZOLA DI NYLON	MAXIMA
2761	ROSSHAARBÜRSTE / HORSEHAIR BRUSH BROSSE EN CRIN DE CHEVAL / SPAZZOLA DI CRINE DI CAVALLO	MAXIMA
2762	FIBERBÜRSTE / FIBRE BRUSH BROSSE EN FIBRES / SPAZZOLA IN FIBRA	MAXIMA

### UNIVERSAL-FLOCKENWACHS

Universal wax chips / Fart en flocons universel / Sciolina a scaglie universale

für / for / pour / per: FLUID WAXER

5kg

105809 – 15 °C bis + 5 °C transparent



! Keine Fluorwachse verwenden!  
No fluor wax!  
Pas de farts au fluor!  
Non usare sciolina fluorata!



## WACHSEN, POLIEREN UND ZUBEHÖR

WAXING, POLISHING AND ACCESSORIES / FARTAGE, POLISSAGE  
ET ACCESSOIRES / SCIOLINATURA, LUCIDATURA ED ACCESSORI

### MONTANA SPECIAL WAX

4 x 250 g 130 x 155 x 12 mm

für / for / pour / per: FLUID WAXER

106088	- 5 °C bis + 5 °C	gelb / yellow / jaune / giallo	
106089	- 15 °C bis - 5 °C	grün / green / vert / verde	
106090	- 20 °C bis - 10 °C	blau / blue / bleu / blu	A

für / for / pour / per: SAPHIR, CHALLENGE

2 x 1300 g 330 x 164 x 25 mm

106547	- 5 °C bis + 5 °C	gelb / yellow / jaune / giallo	
107298	- 15 °C bis - 5 °C	grün / green / vert / verde	

für / for / pour / per: ONYX

2 x 750 g 178 x 164 x 25 mm

109437	- 5 °C bis + 5 °C	gelb / yellow / jaune / giallo	
109438	- 15 °C bis - 5 °C	grün / green / vert / verde	

### WINTHERACE COVER-FLUID

109099	15 ml	DE	A
109101	100 ml	DE	
109100	100 ml	EN	
109102	100 ml	FR	A
109103	100 ml	IT	A
109015	1000 ml	DE	

### KUNSTSTOFF-ABZIEHKLINGE

Plexi wax scraper / Raclor plastique / Raschietto in plastica

102086	Ski
102087	Snowboard

### STAHLABZIEHKLINGE

Steel wax scraper / Raclor en acier / Raschietto in acciaio

mit Etui / with case / avec étui / con astuccio

102085	Ski
102088	Snowboard

### WACHSENTFERNER

Wax remover / Défarteur / Toglio sciolina

104883	1 lt
--------	------

## KANTENPRÄPARATION UND SCHUTZAUSRÜSTUNG

SIDE EDGE PREPARATION AND PROTECTIVE GEAR / PRÉPARATION DES CARRES ET  
EQUIPEMENT DE PROTECTION / PREPARAZIONE DELLE LAMINE ED ATTREZZATURA DI PROTEZIONE

### DIAMANTFEILE

Diamond file / Lime de diamant / Lima di diamante

für / for / pour / per: FLUID WAXER

105496	200 K	rot / red / rouge / rosso	
105497	600 K	weiss / white / blanc / bianco	
105498	1500 K	blau / blue / bleu / blu	

### FEILENWINKEL (OHNE HALTEKLAMMER)

Edge guide (without holder)

Equerre guide alu (sans pince)

Lima angolare (senza pinze di supporto)

105928	89°	
102084	88°	
102083	87°	
102082	86°	A

### HALTEKLAMMER

Edge angle holder / Pince pour limes / Pinza di supporto

102059	
--------	--

### FINNFEILE

Finn file / Lime finn / Lima finn

102089	200 mm
--------	--------

### KAROSSERIEFEILE

Flexible file / Lime de carrossier / Lima di carrozzeria

106276	350 mm, Z1
--------	------------

### UNIVERSALFEILE

Universal file / Lime universelle / Lima universale

102081	120 mm
--------	--------

### KANTENGUMMI UNIVERSAL

Abrasive block / Gomme caoutchouc universel / Gomma abrasiva universale

105869	63 x 40 x 20 mm
--------	-----------------

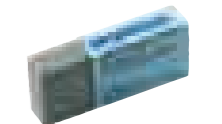

## KANTENPRÄPARATION UND SCHUTZAUSRÜSTUNG

SIDE EDGE PREPARATION AND PROTECTIVE EQUIPMENT / PRÉPARATION DES CARRES ET EQUIPEMENT DE PROTECTION PREPARAZIONE DELLE LAMINE ED ATTREZZATURA DI PROTEZIONE



HAARLINEAL	
True bar / Règle de précision / Righello di precisione	
mit Etui / with case / avec étui / con astuccio	
*102057	125 mm



KANTEN- UND STRUKTURLUPE	
Pocket magnifier for edges and structures	
Loupe pour structures et carres latérales	
Lente d'ingrandimento per lamina e impronte	
Zur Prüfung von Rauhtiefe und Struktur	
To verify edges and structures	
Pour le contrôle de l'aiguisage et des structures	
Per verificare rugosità e impronte	
*105909	



PRÄZISIONS-WINKELMESSGERÄT	
Precision goniometer	
Goniomètre de précision	
Misuratore angolare di precisione	
*102056	



NEIGUNGSENSOR DIGITAL	
Digital inclination sensor	
Capteur de basculement digital	
Sensore di inclinazione digitale	
*109279	A



SCHUTZBRILLE	
Protective glasses / Lunettes protectrices / Occhiali di protezione	
mit UV-Schutz / with UV protection / avec protection UV / con protezione UV	
*106234	Stück / piece / pièce / pezzi



FEINSTAUBMASKE MIT FILTER	
Fine dust mask with filter	
Masque anti-poussière avec filtre	
Maschera anti-polveri fini con filtro	
*107803	Box à 10 Stück / pieces / pièces / pezzi

GEHÖRSCHUTZ	
Ear plugs / Bouchons auriculaires / Cuffie protettive	
*106235	Box à 10 Stück / pieces / pièces / pezzi



SCHUTZHANDSCHUHE	
Protective gloves / Gants de protection / Guanti protettivi	
Paar / pair / paire / paio	
*108773	Grösse / size / taille / misura: M
*107035	Grösse / size / taille / misura: L
*107036	Grösse / size / taille / misura: XL



## SCHABLONEN

TEMPLATES / GABARITS / SAGOME

CARVING-SCHABLONE	
Templates for carving / Gabarit carving / Sagome per carving	
klein / short / petit / piccolo	
105285	120 – 150 cm A



KINDERSKI-SCHABLONE	
Templates for children skis	
Gabarits pour skis enfants	
Sagoma per sci da bambino	
101979	75 – 90 cm A
101977	ab / from / dès / da: 90 cm A

LANGLAUFKIS-SCHABLONE	
Template for XC-skis / Gabarit pour skis nordiques / Sagoma per sci di fondo	
101980	mit Halterung / with holder / avec fixation / con supporto A



ERSATZ-GUMMIKEIL FÜR SCHABLONEN	
Replacement-rubber wedge for templates	
Cale en caoutchouc de remplacement pour gabarits	
Cuneo in gomma di ricambio per sagome	
101994	Stück / piece / pièce / pezzi



## SCHABLONEN

TEMPLATES / GABARITS / SAGOME



<b>ANTI-RUTSCH-FOLIE FÜR SCHABLONEN</b>			
Anti-slide foil for templates			
Grip antiglisse pour gabarits			
Foglio antiscivolo per sagome			
106859	75 x 1060 mm		
106860	75 x 1320 mm		A



<b>GUMMI FÜR SNOWBOARDS</b>			
Rubber strip for snowboards			
Bande caoutchouc pour snowboards			
Striscia di gomma per snowboard			
104064	4 x 60 x 1580 mm		A



<b>MITTELPUFFER MIT RASTERVERSCHLUSS</b>			
Center support with snap system			
Système de support central réglable avec plaque de fixation			
Supporto centrale con chiusura a scatto			
für Carving Schablone for carving template pour gabarit carving per sagome per carving			
105837			A



<b>SKISTOPPER-GUMMIRINGE</b>			
Skistopper rubber bands			
Elastiques pour stopper de skis			
Anelli di gomma per ski stopper			
Emulsionsresistent Emulsion resistant Résistants à l'émulsion Resistenti alle emulsioni			
105839	50 Stück / piece / pièce / pezzi	blau / blue / bleu / blu	
108208	200 Stück / piece / pièce / pezzi	blau / blue / bleu / blu	



<b>WERKSTATTSCHÜRZE</b>			
Shop apron / Tablier d'atelier / Grembiule da officina			
105734	schwarz / black / noir / nero		

## SCHLEIFMITTELKONZENTRAT UND PFLEGEMITTEL

ABRASIVE CONCENTRATE AND CARE PRODUCTS / CONCENTRÉ ABRASIF ET PRODUITS D'ENTRETIEN / PRODOTTI ABRASIVI CONCENTRATI E PRODOTTI DI CURA

<b>SCHLEIFMITTELKONZENTRAT V3</b>			
Abrasive concentrate / Concentré abrasif / Prodotti abrasivi concentrati			
Kanister / canister / bidon / tanica			
108451	70 ml	V3	
106383	5 lt	V3	
106384	10 lt	V3	
106385	25 lt	V3	



<b>SCHLEIFMITTELKONZENTRAT MX10</b>			
Abrasive concentrate / Concentré abrasif / Prodotti abrasivi concentrati			
Kanister / canister / bidon / tanica			
109971	5 lt	MX10	
109970	10 lt	MX10	
109960	25 lt	MX10	



<b>JETMIX – EMULSIONSMISCHER</b>			
Emulsion mixer / Mélangeur d'emulsion / Miscelatore per emulsioni			
*101861	ohne Eimer / without bucket / sans seau / senza secchio		
100302	Adabter zu 25 lt Kanister / Adapter for 25 l container Adaptateur pour bidon de 25 litres / Adattatore per confezioni da 25 litri		



<b>CALCIUMACETAT-LÖSUNG FÜR STANDART SCHLEIFEMULSION</b>			
Calcium acetate solution for standard grinding emulsion			
Solution d'acétate de calcium pour emulsion de ponçage standard			
Soluzione di acetato di calcio per emulsioni di rettifica standard			
gebrauchsfertig, schaumhemmend ready to use, antifoam prête à l'emploi, anti-mousse pronto all'uso, antischiumogeno			
106127	1 lt		
107314	5 lt		



<b>SYSTEMREINIGER/ STABILISATOR</b>			
System cleaner / Stabilizer			
Nettoyant de système / Stabilisateur			
Detergente per sistema / Stabilizzatore			
Zur Stabilisierung der Schleifemulsion sowie zur Reinigungsunterstützung vor einer Neubefüllung To stabilise the grinding emulsion and to enhance the cleaning before refilling Pour stabiliser l'émulsion abrasive et le support de nettoyage avant d'une recharge Per stabilizzare l'emulsione di rettifica e il supporto di pulizia prima di una ricarica			
108967	1 lt		
109123	10 lt		



## SCHLEIFMITTELKONZENTRAT UND PFLEGEMITTEL

ABRASIVE CONCENTRATE AND CARE PRODUCTS CONCENTRÉ ABRASIF ET  
PRODUITS D'ENTRETIEN PRODOTTI ABRASIVI CONCENTRATI E PRODOTTI DI CURA



### EMULSIONS-ENTSCHÄUMER SCHLEIFEMULSION

Calcium acetate solution grinding emulsion  
Solution d'acétate de calcium pour emulsion  
Soluzione di acetato di calcio per emulsioni

gebrauchsfertig, schaumhemmend  
ready to use, antifoam  
prête à l'emploi, anti-mousse  
pronto all'uso, antischiumogeno

*107398	1 lt	
110111	1 lt	MX 10

### REFRAKTOMETER ATAGO

Refractometer Atago / Réfractomètre Atago / Refrattometro Atago

neue Skala 0.0 – 20.0% / new scale 0.0 – 20.0% /  
nouvelle dimension 0.0 – 20.0% / nuova scala

*108968	Stück / piece / pièce / pezzo	
---------	-------------------------------	--

### PH-WERT-INDIKATORSTÄBCHEN

pH value indicator strips / Barres indicatrices de pH / Barre indicatori di pH

*109036	100 Stück / piece / pièce / pezzo	
---------	-----------------------------------	--

### HÄRTEMESSTÄBCHEN

Hardness test strips  
Barres de mesure de la dureté  
Barre di misura della durezza

*109037	100 Stück / piece / pièce / pezzo	
---------	-----------------------------------	--

### MASCHINEN-REINIGERKONZENTRAT

Cleaning concentrate for machines  
Nettoyant concentré pour machines  
Concentrato detergente per macchine

*101867	5 lt	
---------	------	--

### DRUCKPUMPENZERSTÄUBER MIT VERLÄNGERUNGSROHR

Vaporizer with spray pump and extension tube  
Bouteille à pression avec atomiseur et rallonge  
Vaporizzatore a pressione con cavo di prolunga

lösungsmittelbeständig / resistant against solvents  
résistante aux acides / resistente ai solventi

*105142	1 lt	
---------	------	--

### FILTERSTRUMPF

Nylon filter / Bas filtrant nylon / Base filtrante in nylon

hohe Querdehnung / high transverse stretching performance  
extensible transversalement / ad alta estensibilità trasversale

104929	40 m	
--------	------	--

### FILTERSACK

Filterbag / Sac filtrant / Sacco filtrante

Für Maschinen ohne automatische Schwerkraft-Filterssystem  
For machines without gravity filter system

Pour machines sans système de filtrage automatique  
Per macchine senza sistema filtrante automatico a gravità

*106374	Box à 5 Stück / pieces / pièces / pezzi	
---------	---	--

### FILTERROLLE

Filter roll / Rouleau de filtre / Rullo filtrante

für Schwerkraftfilter  
for gravity filter  
pour système de filtrage automatique  
per filtri a gravità

101890	54 cm x 100 m	T 8	A
101889	54 cm x 100 m	T 12	
106515	75 cm x 100 m	T 12	
106470	100 cm x 100 m	T 12	

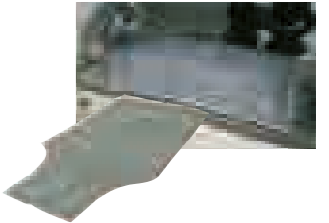

## PFLEGE MITTEL UND MASCHINENZUBEHÖR

CARE PRODUCTS AND ACCESSORIES FOR MACHINES / PRODUITS D'ENTRETIEN ET ACCESSOIRES POUR MACHINES / PRODOTTI PER LA MANUTENZIONE ED ACCESSORI PER MACCHINE



<b>BETTBAHNÖL MONTANA HIGH PERFORMANCE</b>	
Special oil / Huile spéciale / Olio speciale	
*109339	1 lt

<b>PUMPENÖL MONTANA HIGH PERFORMANCE</b>	
Pump oil Montana high performance Huile de pompe Montana Olio per pompe Montana high performance	
*109338	1 lt



<b>ÖLSPRAY</b>	
Oilspray / Spray d'huile / Olio spray	
*100108	500 ml



<b>LANGZEITFETT</b>		
Long-term grease / Graisse à longue durée / Grasso a lunga durata		
*100106	850 g	Dose / tin / boîte / boîte

<b>SPEZIALFETT (FÜR SPINDELLAGER)</b>		
Special grease (for spindle bearings) Graisse spéciale (pour roulements) Grasso speciale (per cuscinetti di mandrini)		
*102068	400 g	Kartusche / cartridge / cartouche / cartuccia



<b>MONTAGE-KRAFTREINIGER SPRAY</b>	
Power-cleaner spray Détergent pour mécanismes Detergente spray per ingranaggi	
*101946	500 ml



<b>INDUSTRIE-SCHAUMREINIGER</b>	
Industrial foam cleaner Nettoyant moussant industriel Schiuma detergente per uso industriale	
*105664	500 ml

<b>SILIKON-DICHTUNGSMASSE</b>	
Silicone sealing material / Mastic silicone / Sigillante in silicone	
310 ml	Kartusche / cartridge / cartouche / cartuccia
*100693	grau / grey / gris / grigio
*106246	anthrazit / anthracite / anthracite / antracite
*106080	weiss / white / blanc / bianco



<b>MONTANA – ORIGINAL MASCHINENFARBE</b>	
Genuine machine colors Couleurs d'origine pour machines Vernici originali per macchine	
500 ml	Spraydosen / Sprayer / Bombe aérosol / Bomboletta spray
*106178	RAL 9016 weiss / white / blanc / bianco
*106179	RAL 7011 grau / grey / gris / grigio



<b>ERSATZMATERIAL ZU MONTANA VAKUUM PLATTEN</b>	
Replacement parts for MONTANA vacuum plates Pièces de rechange pour les plaques à vide MONTANA Ricambi per piastre del vuoto MONTANA	

<b>SAUGGUMMI AUS SILIKON</b>			
Silicone seals / Joints d'aspiration en silicone / Gommini in silicone			
mit Doppel-Lippen / with double-lips / avec double-lèvres / a doppio labbro			
107279	100 x 60 mm	blau weich / blue soft / bleu souple / blu tenue	
107473	80 x 50 mm	blau weich / blue soft / bleu souple / blu tenue	
107055	80 x 30 mm	rot / red / rouge / rosso	LL 80
106348	100 x 30 mm	rot / red / rouge / rosso	LL 100
104950	160 x 30 mm	rot / red / rouge / rosso	LL 160

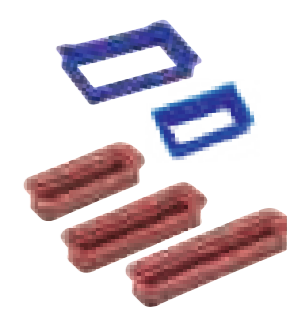

<b>INNENPLATTEN ZU SAUGPLATTEN</b>			
Inner plates for suction plates Plaques intérieures pour plaques d'aspiration Piastre interne per piastre aspiranti			
*107511	100 x 60 mm	9 mm	
*107646	80 x 50 mm	9 mm	
*107057	80 x 30 mm	9 mm	
*106363	100 x 30 mm	9 mm	



## PFLEGE MITTEL UND MASCHINENZUBEHÖR

CARE PRODUCTS AND ACCESSORIES FOR MACHINES / PRODUITS D'ENTRETIEN ET ACCESSOIRES  
POUR MACHINES / PRODOTTI PER LA MANUTENZIONE ED ACCESSORI PER MACCHINE

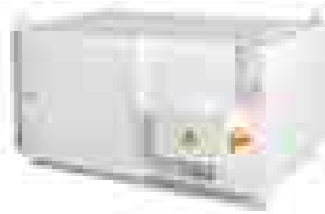

<b>ÖLNEBEL-ABSAUGUNG</b>		
Oil mist extraction / Aspiration du brouillard d'huile / Aspirazione nebbie d'olio		
200408	800 x 400 x 415 mm	Saphir / One / Race / Onyx / Crystal Magic / Rock

<b>OPTIONEN / OPTIONS / OPTIONS / OPZIONI</b>	
110894	Halter Ölnebelabsaugung auf Maschine / Oil mist extraction Aspiration du brouillard d'huile / Aspirazione nebbie d'olio
108764	400 x 480 x 1100 mm Gestell zu Ölnebel-Absaugung Frame for oil mist extraction Support pour l'aspiration du brouillard d'huile Filtro finale VARI per aspirazione nebbie d'olio

<b>VARI – ENDFILTER ZU ÖLNEBEL-ABSAUGUNG</b>	
End filter for oil mist extraction	
Filtre final pour l'aspiration du brouillard	
D'huile / Filtri finali per aspiratore nebbie d'olio	
*107302	

<b>FILTER (RINGE) ZU ÖLNEBEL-ABSAUGUNG</b>	
End filter for oil mist extraction	
Filtre final pour l'aspiration du brouillard d'huile	
Filtro finale per aspiratore nebbie d'olio	
*108971	



<b>FKO 26 – DURCHLAUFKÜHLER</b>	
Flow-through cooler / Refroidisseur à circulation / Refrigeratore a flusso	
230 V, 2.5 kW	
*108263	873 x 505 x 855 mm

<b>DKB 50 – DURCHLAUFKÜHLER</b>	
Flow-through cooler / Refroidisseur à circulation / Refrigeratore a flusso	
3 x 380 V, 5.0 kW	
*108262	1004 x 546 x 1771 mm

<b>SCHRAUBENKOMPRESSOR</b>		
Screw compressor / Compresseur à vis / Compressore a vite		
mit integriertem Kältetrockner / with integrated refrigerant type dryer avec sécheur par réfrigération intégré / con essiccatore a freddo integrato		
Volumenstrom / Volume flow / Débit volumique / Flusso volumetrico: 800 l / min		
*200368	1500 x 665 x 1730 mm	3 x 400 V / 2.2 kW
200446	1500 x 665 x 1730 mm	3 x 400 V / 5.5 kW
200221	1915 x 745 x 1850 mm	3 x 400 V / 7.5 kW
*110892	Fahrwerk zu Kompressor (mit 4 Rollen) / Chassis for compressor (with 4 wheels) Châssis pour compresseur (avec 4 roulettes) / Telaio a compressore (con 4 ruote)	



## HYGIENEMITTEL UND IONISATION

HYGIENIC PRODUCTS AND IONIZATION / PRODUITS HYGIÉNIQUES ET IONISATION / PRODOTTI IGIENICI E IONIZZAZIONE

<b>NEUTRALIZER ONE</b>		
Neutraliser / Neutralisateur / Neutralizzatore		
100 – 240 V, 4.3 A, 47 – 63 Hz		
Gerät zur Geruchsneutralisation		
Odour neutralisation device		
Appareil pour la neutralisation des odeurs		
Dispositivo di neutralizzazione degli odori		
200383	Neutralizer ONE	50 x 30 x 64 cm



<b>NEUTRALIZER</b>		
Neutraliser / Neutralisateur / Neutralizzatore		
100 – 240 V, 4.3 A, 47 – 63 Hz		
Hygienemittel für alle Schuh- und Helmtypen		
Hygienic agent for all types of shoes and helmets		
Produits hygiéniques de tous types de chaussures et de casques		
Prodotti igienici per tutti i tipi di scarponi e caschi		
401240	Neutralizer Pro 65 x 40 x 64 cm	benötigt externe Druckluft, geeignet für hohen Durchsatz needs external compressed air, suitable for high throughput nécessite de l'air comprimé externe, adapté à un débit élevé richiede aria compressa esterna, adatta per alte portate
400652	Neutralizer	65 x 40 x 64 cm
400662	Tisch / table / table / tavolo	



## HYGIENEMITTEL UND IONISATION

HYGIENIC PRODUCTS AND IONIZATION / PRODUITS HYGIÉNIQUES  
ET IONISATION / PRODOTTI IGIENICI E IONIZZAZIONE



### MONTANIZER – DESINFEKTION MIT DUFTSTOFF

wirksam gegen Coronavirus, effective against coronavirus  
lutte également de façon efficace contre le coronavirus, efficace anche contro il coronavirus  
Schweiz / Switzerland / Suisse / Svizzera

110289	Montanizer 10lt	Desinfection, Désinfection, Disinfezione
110947	Montanizer 5lt	Desinfection, Désinfection, Disinfezione

### MONTANIZER – TEXTILERFRISCHER

International / International / Internazionale / Internazionale

110490	Montanizer 10lt	Textil freshener, Désodorisant pour textiles, Deodorante per tessuti
110946	Montanizer 5lt	Textil freshener, Désodorisant pour textiles, Deodorante per tessuti

### MONTANA HYGIENEMASKE

**MONTANA hygiene mask**  
**Masque d'hygiène MONTANA**  
**Maschera igienica MONTANA**

Entspricht den Empfehlungen der SWISS NATIONAL COVID-19 TASK FORCE  
8-10x waschbar bei 30° / 3 Lagen für höchsten Schutz  
Complies with the recommendations of SWISS NATIONAL COVID-19 TASK FORCE  
8-10x washable at 30° / 3 layers for highest protection  
Conforme aux recommandations du SWISS NATIONAL COVID-19 TASK FORCE  
8-10x lavable à 30° / 3 couches pour une protection maximale  
Conforme alle raccomandazioni della SWISS NATIONAL COVID-19 TASK FORCE  
8-10x lavabile a 30° / 3 strati per la massima protezione  
700040



### AIR CLEAN UVC / LUFTENTKEIMUNG GEGEN COV-2 VIRUS

**Reduces the SARS-CoV-2 virus by 99%**  
**Réduction d'environ 99% de la quantité de virus SARS-CoV-2**  
**Riduzione del 99% del virus SARS-CoV-2**

401448	Air Cleaner PIURO	A
401447	Standfuss	A

### IONISATIONSGERÄT, 230 V

**Ionisation device / Ionisateur / Ionizzatore**

Die effiziente Lösung zur Luftreinigung und Geruchsabeseitigung  
The efficient solution for air cleaning and removal of malodour  
La solution efficace pour purifier l'air et éliminer les odeurs  
La soluzione efficiente per la pulizia dell'aria e l'annientamento di odori

104821	für / for / pour / per:	320 m <sup>3</sup> / h; 35 W, 7-E, 60 x 24 x 14 cm
104843	für / for / pour / per:	235 m <sup>3</sup> / h; 35 W, 7-D, 60 x 24 x 14 cm

### IONISATIONSROHRE

**Ionisation tube / Tube d'ionisation / Tubi di ionizzazione**

*106320	Typ E TL = 370 mm
*108177	Typ D TL = 250 mm
*105425	Typ C TL = 150 mm



## WERKSTATTEINRICHTUNG UND WERKZEUGE

WORKSHOP TOOLS / AMÉNAGEMENT DE L'ATELIER  
ET OUTILS / ATTREZZATURA DA OFFICINA E UTENSILI

### WERKBÄNKE

**Workbenches / Etablis / Banco da lavoro**

In verschiedenen Ausführungen und Massen innerhalb 6 Wochen lieferbar.  
Bitte fragen Sie bei uns an.  
Any dimension or style can be delivered in 6 weeks,  
please ask for details.  
Differentes variantes et dimensions sont livrables en 6 semaines,  
demandez nous pour des renseignements détaillées.  
In diversi modelli e misure, fornitura possibile entro 6 settimane.  
Vi preghiamo di mettervi in contatto con noi.



### FEDERZUG

**Balancer / Câble à ressort / Cavo a molla**

\*102045



### GUMMIWABENMATTE

**Rubber mat / Tapis anti-glissant / Stuoia in gomma a nido d'ape**

102073	1180 x 780 x 23 mm	geschlossen / closed / fermé / chiusa
104989	1180 x 780 x 23 mm	offen / open / ouvert / aperta



### HALTERUNG FÜR PAPIERROLLE UND MÜLLSACK

**Stand for cleaning roll and waste bag**  
**Support pour rouleau de papier et sac poubelle**  
**Supporto per rullo di carta e sacchi per rifiuti**

\*102054 ohne Papier / without paper / sans papier / senza carta



### WERKSTATT PAPIER

**Shop paper towels / Papier de nettoyage / Carta da officina**

3-lagig, ca. 1000 Abrisse  
3 layers, approx. 1000 sections  
3 couches, env. 1000 pièces par rouleau  
3 strati, ca. 1000 strappi per rotolo  
102053

### PUTZTÜCHER-BOX

**Cleaning clothbox**  
**Box à feuilles de nettoyage**  
**Box per fazzoletti di pulizia**

110288 100 Blatt / cloth / feuilles / fogli



## WERKSTATTEINRICHTUNG UND WERKZEUGE

WORKSHOP TOOLS / AMÉNAGEMENT DE L'ATELIER ET OUTILS  
ATTREZZATURA DA OFFICINA E UTENSILI

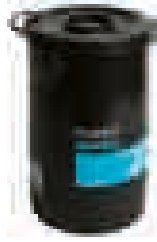

### POWER WIPES REINIGUNGSTÜCHER

Cleaning cloths  
Chiffons de nettoyage  
Panni per la pulizia

Vielseitig einsetzbar, getränkt mit kräftigem, industriellem Reiniger  
Versatile, impregnated with powerful industrial cleaner  
Utilisation polyvalente, imprégné dans un puissant nettoyeur industriel  
Multiuso, imbevuti di potente detergente industriale

108518 Box à 90 Tücher / tissues / papiers / fazzoletti



### WISCHER ZUR SKIREINIGUNG

Wiper for ski cleaning  
Gomme pour l'essuyage des skis  
Gomma per pulizia di sci

107292 20 mm



### SCHNELLSPANNER INKL. BINDUNGSFIXATION

Bench vice including fixation for the bindings  
Étau de montage avec fixation pour l'établi  
Tenditore rapido, con fissaggio per attacchi inclusi

107772 für / for / pour / per 1 Ski

A



### SCHNELLSPANNER INKL. BINDUNGSFIXATION 60 °

Quick release, incl. fixation for bindings 60 °  
Dispositif de fixation rapide comprenant une attache des fixations 60 °  
Tenditore a serraggio rapido, incl. fissaggio per attacchi 60 °

108460 für / for / pour / per 1 Ski

A



### NORDIC ADAPTER

Nordic adapter / Adaptateur nordique / Adattatore sci da fondo

107773

A



### BINDUNGSFIXIERUNG

Elastic fixation for the bindings  
Elastique caoutchouc pour fixation  
Elastico di fissaggio per attacchi

107774

A

### ALPE 2000 SUPER II – SCHNELLSPANNER

Bench vice  
Étau de montage  
Tenditore rapido

Profi-Doppel-Schnellspanner für alle Skiarten und Snowboards,  
speziell geeignet für Breitski.

Professional double vice for all kinds of skis and snowboards,  
especially for large skis.

Étau de montage professionnel double pour tous les skis et snowboards,  
approprié pour des skis larges.

Tenditore rapido doppio professionale per tutti i tipi di sci e snowboard,  
particolarmente adatto per sci larghi.

\*106444 für / for / pour / per 2 Ski / 1 Snowboard



## BINDUNGSMONTAGE

BINDING MOUNTING / MONTAGE DES FIXATIONS  
MATERIALE PER IL MONTAGGIO DEGLI ATTACCHI

### SCHRAUBEREINSATZ FÜR ELEKTROSCHRAUBER

Drill bits for power-screwdriver  
Embouts pour visseuse  
Inserto giravite

sechskant / hexagon / hexagone / esagonale

105442 150 mm Grösse / size / grandeur / misura: 3

für FEIN Schrauber, altes Modell / for FEIN power-screwdriver, old model  
pour visseuse FEIN, ancien modèle / per cacciaviti FEIN, vecchio modello

Kreuzschlitz / Philipps / pointe Philipps / a croce

102038 120 mm Grösse / size / grandeur / misura: 3



### BINDUNGSBOHRER

Drill bits for bindings  
Mèches pour fixations  
Punte da trapano

102116 3.5 x 7.0 mm

102117 3.5 x 9.0 mm

102115 3.5 x 11.0 mm

A

105879 3.5 x 15.0 mm

105883 3.6 x 9.0 mm

105884 3.8 x 9.0 mm

105886 4.1 x 7.5 mm

102120 4.1 x 9.0 mm

105887 4.1 x 9.5 mm

102121 4.5 x 9.0 mm

A



## BINDUNGSMONTAGE

BINDING MOUNTING / MONTAGE DES FIXATIONS  
MATERIALE PER IL MONTAGGIO DEGLI ATTACCHI



### BINDUNGSBOHRER NANO BESCHICHTET

Drill bits nano coated  
Mèches pour le montage des fixations recouverte de nano  
Punte da trapano nano-rivestite

extrem hohe Standzeiten / high servicetime / haute durée d'utilisation  
durate d'uso estremamente prolungate

107031	4.1 x 9.0 mm	
107032	4.1 x 9.5 mm	
107033	4.5 x 9.0 mm	A
108113	3.5 x 9.0 mm	



### HOHLBOHRER

Hollow drill bit / Mèche creuse / Punta per trapano a corona

102098	Ø 8 mm	
--------	--------	--



### ANSCHLAGBOHRER

Gaugedrill / Mèche avec butée de profondeur / Punta per trapano a battuta

102094	Ø 8 mm	
--------	--------	--



### GEWINDESCHNEIDER

Gauge drill / Taraud pour plaque métallique / Filettatore

102092	5.3 mm x 1.81 mm	vierkant / tetrahedral / carré / quadrato
--------	------------------	---



### ALPIN BINDUNGSSCHRAUBEN

Binding screws for alpine skis  
Vis de fixation pour skis alpin  
Viti per attacchi per sci alpino

100 Stück / pieces / pièces / pezzi		
105898	5.5 mm x 9.5 mm	A
105899	5.5 mm x 11.5 mm	A
105900	5.5 mm x 13.0 mm	A
105901	5.5 mm x 15.0 mm	A
105902	5.5 mm x 16.0 mm	A

### COLLTANA S

Kleber für Bindungsschrauben / Glue for binding screws  
Colle pour vis de fixation  
Sigillante per viti di attacchi

109290	300 ml	
--------	--------	--



### SWISSTOOL – SCHRAUBENDREHER-SATZ

Screwdriver set / Jeu de tournevis / Set giraviti

Ergonomischer Spezialgriff mit hoher Grifffestigkeit  
Ergonomical special grip for high performance  
Poignée spéciale ergonomique avec une adhérence excellente  
Manico ergonomico speciale di elevata aderenza

105889	Grösse / size / grandeur / misura: Pz 2, Pz 3, 6	A
--------	--	---



### SWISSTOOL – SCHRAUBENDREHER

Screwdriver / Tournevis / Giravite

105891	Grösse / size / grandeur / misura: Pz 2	A
105890	Grösse / size / grandeur / misura: Pz 3	

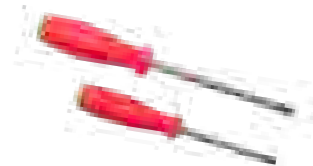

### KUNSTSTOFF-PFROPFEN

Plastic hole plugs / Bouchons en plastique / Tappini in plastica

Ø 4.6 mm Box à 500 Stück / pieces / pièces / pezzi		
101925	transparent / clear / transparent / trasparente	
101926	schwarz / black / noir / nero	
101927	bunt gemischt / mixed colours / couleurs mélangées / multicolore	
101940	grau / grey / gris / grigio	
101941	weiss / white / blanc / bianco	
101942	rot / red / rouge / rosso	A

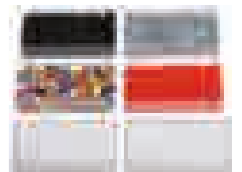

## BINDUNGSMONTAGE

BINDING MOUNTING / MONTAGE DES FIXATIONS  
MATERIALE PER IL MONTAGGIO DEGLI ATTACCHI



<b>PLASTIKDÜBEL</b>		
Plastic inserts Goujons en plastique Tasselli in plastica		
102096	9 x 8.5 mm	100 Stück / pieces / pièces / pezzi



<b>MESSINGDÜBEL</b>		
Brass inserts Goujons en laiton Tasselli in ottone		
102093	9 x 8.5 mm	50 Stück / pieces / pièces / pezzi

## FLIP CLIP & WERKSTATT RACKS

FLIP CLIP & WORKSHOP RACKS / FLIP CLIP & CHARIOTS D'ATELIER  
FLIP CLIP & CARRELLI DA OFFICINA

<b>EASY HANG – TRAVERSE</b>		
Cross-beam Traverse Traversa		
Mit Halterung und Ausleger ohne Befestigungsmaterial With support and extension without fixation material Avec support et potence, sans matériel de fixation Con supporto e braccio di sostegno, senza materiale di fissaggio		
1-reihig / 1 row / 1 rangée / 1 fila		
401167	100 cm	12 Ski / 16 Kinderski / children skis skis pour enfants / sci da bambino
401168	150 cm	18 Ski / 24 Kinderski / children skis skis pour enfants / sci da bambino

6-reihig / 5 rows / 5 rangées / 5 file		
401170	100 cm (4-Pol)	12 Ski / 16 Kinderski / children skis skis pour enfants / sci da bambino
401171	150 cm (4-Pol)	18 Ski / 24 Kinderski / children skis skis pour enfants / sci da bambino

<b>SNOWBOARD, MIX – TRAVERSE</b>		
Cross-beam Traverse Traversa		
Mit Halterung und Ausleger ohne Befestigungsmaterial With support and extension without fixation material Avec support et potence, sans matériel de fixation Con supporto e braccio di sostegno, senza materiale di fissaggio		
1-reihig / 1 row / 1 rangée / 1 fila		
401172	100 cm	5 / 22 Snowboards
401173	150 cm	8 / 34 Snowboards



<b>WANNE MIT MATTE</b>		
Tray with mat Bac pour traverse avec tapis Base con stuoia		
zu / for / pour / per: Easy Hang, Snowboard, MIX		
1-reihig / 1 row / 1 rangée / 1 fila		
401174	100 cm	
401175	150 cm	



<b>POLE RACK - WALL MOUNTED</b>		
401169	100 cm	120 Paar / pairs / paires / paia



<b>POLE RACK WALL</b>		
Das flexible Regal für Ski- und Langlaufstöcke The flexible shelf for ski and cross-country ski poles L'étagère flexible pour les bâtons de ski et de ski de fonds Lo scaffale flessibile per bastoncini da sci e sci da fondo		
höhenverstellbare Halterungen height-adjustable brackets crochets à hauteur réglable supporti regolabili in altezza		
400827	100 x 80 x 240 cm	240 Paar / pairs / paires / paia
400828	150 x 80 x 240 cm	360 Paar / pairs / paires / paia

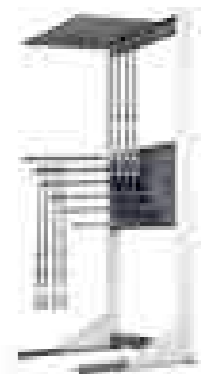

## FLIP CLIP & WERKSTATT RACKS

FLIP CLIP & WORKSHOP RACKS / FLIP CLIP & CHARIOTS  
D'ATELIER / FLIP CLIP & CARRELLI DA OFFICINA



### BUTLER

Transport- und Sammelwagen mit Rollenfahrwerk. Bietet Platz für die komplette Skiausrüstung von 6 Personen. Mit Ablagekorb für Kleinteile.

Transport rack on swivelling wheels. Space on rack for 6 people's complete ski equipment. Including basket for small items.

Meuble sur roulettes pouvant recevoir l'équipement de ski pour 6 personnes. Equipé d'une corbeille pour divers accessoires.

Carrello di trasporto e di raccolta con struttura mobile. Offre posto sufficiente per l'intera attrezzatura da sci di 6 persone. Con cestello di appoggio per piccoli pezzi.

400802	50 x 100 cm	A
--------	-------------	---

### HELMHALTER 3-TEILIG ZU BUTLER

3-part helmet mount for butler

Accroche casque en 3 parties de Butler

Supporto per casco in 3 pezzi per butler

Verstaumöglichkeit für 6 Helme, 6 Brillen, 6 Paar Handschuhe

Storage option for 6 helmets, 6 goggles, 6 pairs of gloves

Rangement pour 6 casques, 6 paires de lunettes, 6 paires de gants

Spazio di conservazione per 6 caschi, 6 occhiali e 6 paia di guanti

401166	50 x 100 cm
--------	-------------



### TRANSPORT RACK

Bietet Platz für eine grosse Auswahl von Sportgeräten

Offers space for a wide range of sports equipment

Offre de l'espace pour une vaste gamme d'équipements sportifs

Offre spazio per una vasta gamma di attrezzature sportive

401247	110 x 77 x 192.7 cm
--------	---------------------

401253
--------



### WERKSTATTWAGEN

Workshop trolley / Chariot de service / Carrello per officina

für ca. 30 Paar Ski, Fahrwerk mit 4 Lenkrollen davon 2 mit Bremsen  
for approx. 30 pairs of skis, with 4 casters, 2 with brakes

capacité env. 30 paires de ski, châssis avec 4 roulettes, 2 avec freins

per ca. 30 paia di sci, mobile e con 4 rotelle, di cui 2 dotate di freni

400644	80 x 120 cm
--------	-------------

### UNIVERSAL WERKSTATT

Auf Rollfahrwek mit Gummischlauch in oberer Querstange um seitliches Rutschen zu vermeiden (inkl. Wasserauffangbecken).

On rolling chassis with rubber hose in the upper cross-bar to prevent lateral slipping (incl. catch basin for water).

Sur châssis roulant avec un tuyau en caoutchouc dans l'arbre transversal afin d'éviter un glissement latéral (y compris bassin de rétention d'eau).

Con telaio a rotazione con tubo flessibile in gomma nella barra trasversale superiore, per evitare lo scivolamento laterale (con serbatoio di raccolta dell'acqua incluso).

401212	45 x 100 cm	16 Paar / pairs / paires / paia
--------	-------------	---------------------------------

401213	45 x 150 cm	24 Paar / pairs / paires / paia
--------	-------------	---------------------------------



### UNIVERSAL RACK

Mit extra grossen Rollen / With extra large rollers

Avec très grandes roulettes/ Con ruote extra large

Umbausatz fahrbar mit 3 Räder

Conversion kit for 3 wheel mobility

Kit de conversion mobile sur 3 roues

Kit di conversione mobile su 3 ruote

401569	Ø 260mm
--------	---------



### PRÄSENTATIONSSTÄNDER WEISS FÜR 8 PAAR

White presentation stand for 8 pairs / Support de présentation blanc pour 8 paires

Stand di presentazione bianchi per 8 paia

Pulverbeschichtet mit zusätzlichem Kantenschutz

Powder coated with additional edge protection

Revêtu de poudre avec protection supplémentaire des bords

Verniciati a polvere con protezione aggiuntiva dei bordi

400978	80 x 50 x 120 cm	min. 8 Paar / 8 pairs / 8 Paires / 8 Paia
--------	------------------	---

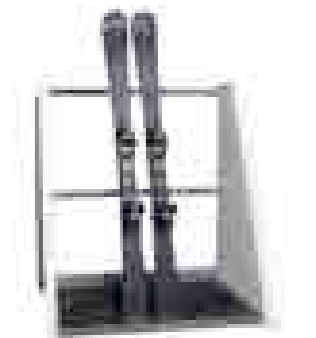

### PRÄSENTATIONSSTÄNDER WEISS

White presentation stand / Support de présentation blanc / Stand di presentazione bianchi

Pulverbeschichtet mit zusätzlichem Kantenschutz

Powder coated with additional edge protection

Revêtu de poudre avec protection supplémentaire des bords

Verniciati a polvere con protezione aggiuntiva dei bordi

401525	38 x 48 x 120 cm	min. 3 Paar / 3 pairs / paires / 3 Paia
--------	------------------	---



## FLIP CLIP & WERKSTATT RACKS

FLIP CLIP & WORKSHOP RACKS / FLIP CLIP &  
CHARIOTS D'ATELIER / FLIP CLIP & CARRELLI DA OFFICINA



### FLIP CLIP

50 cm mit Schiene / with rail / avec rail / con guida

102788	Trio	3 Stück / pieces / pièces / pezzi
102792	Trio 40°	3 Stück / pieces / pièces / pezzi

95 cm mit Schiene / with rail / avec rail / con guida

102789	Quintett	5 Stück / pieces / pièces / pezzi
102793	Quintett 40°	5 Stück / pieces / pièces / pezzi



### FLIP CLIP «EASY» – MONTAGESCHIENE

Mounting rail / Rail de montage / Guida di montaggio

107978	pro Meter / per meter / par mètre / al metro
--------	--



### FLIP CLIP

mit Grundplatte / with base plate / avec plaque de base / con piastra di base

102787	Flip Clip	Stück / piece / pièce / pezzi
102797	Flip Clip 40°	Stück / piece / pièce / pezzi

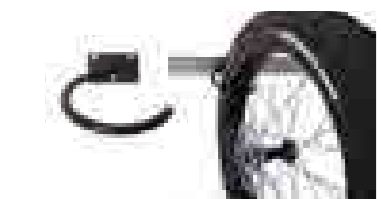

### FAHRRADHAKEN SCHWARZ MIT FELGENSCHUTZ

Bicycle hook black with rim protection

Crochet noir pour vélo avec protection de la jante

Gancio nero per bicicletta con protezione del cerchio

109664	Stück / piece / pièce / pezzo
--------	-------------------------------



### FAHRRAD-PARKER

Bike-Parker / Parc pour vélos / Parcheggio bici

Mindestbestellmenge 3 Stück / Quantité minimale de commande 3 pièces

Stück / piece / pièce / pezzo

*400833	Stück / piece / pièce / pezzo
---------	-------------------------------

### SCHUHTROCKNER VERSION AIR / ELEKTRO (EU)

Shoe dryer version E/A / Sèche-chaussures version E/A / Asciugascarpe versione E/A

mit Kontaktwärme Version E / with contact heat version E

avec chaleur de contact version E / con calore di contatto versione E

mit Warmluft Version A / with hot air version A

avec air chaud version A / con aria calda versione A

401301	Trockner A Warmluft / Dryer A warm air Séchoir A air chaud / Asciugatrice A aria calda 10 Paar / pairs / paires / paia 65 cm x 190 cm 1 x 230 V AVC / 50 Hz, 1600 Watt
--------	---

401351	Trockner-Anbaumodul A links / Dryer add-on module A left Module de montage du séchoir A gauche / Modulo di estensione dell'asciugatrice A sinistra 10 Paar / pairs / paires / paia 1 x 230 V AC / 50 Hz, 360 Watt 65 cm x 190 cm
--------	---

401300	Trockner E Elektro / Dryer E electric Séchoir E électrique / Asciugatrice E elettrica 10 Paar / pairs / paires / paia 1 x 230 V AC / 50 Hz, 400 Watt 65 cm x 170 cm
--------	--

401361	Trockner-Anbaumodul E links / Dryer extension module E left Module d'extension de séchoir E gauche / Modulo di estensione dell'asciugatrice E sinistra 10 Paar / pairs / paires / paia 1 x 230 V AC / 50 Hz, 360 Watt 65 cm x 170 cm
--------	---

### VERSION AIR / ELEKTRO (USA)

401325	Trockner A Warmluft / Dryer A warm air Séchoir A air chaud / Asciugatrice A aria calda 10 Paar / pairs / paires / paia 65 cm x 190 cm 1 x 115 V AVC / 60 Hz, 1100 Watt
--------	---

401352	Trockner-Anbaumodul Air links USA 120 V Dryer add-on module Air left USA 120 V Module de montage de séchoir Air gauche USA 120 V Modulo aggiuntivo di asciugatura Ari sinistra USA 120 V
--------	---

401324	Trockner E Elektro / Dryer E electric Séchoir E électrique / Asciugatrice E elettrica 10 Paar / pairs / paires / paia 1 x 115 V AC / 60 Hz, 400 Watt 65 cm x 170 cm
--------	--

401362	Trockner-Anbaumodul E links / Dryer extension module E left Module d'extension de séchoir E gauche / Modulo di estensione dell'asciugatrice E sinistra 10 Paar / pairs / paires / paia 1 x 115 V AC / 60 Hz, 360 Watt 65 cm x 170 cm
--------	---

### OPTIONEN / OPTIONS / OPTIONS / OPZIONI

600374	Standfüsse zu Trockner / Stand feet to dryer Pieds pour séchoir / Piedi per asciugatrice für EU und USA Version erhältlich / available for EU and USA version disponible pour les versions UE et USA / disponibile per la versione EU e USA
--------	--

600381	Wandhalterung zu Trockner / Wall mount dryer Support pour montage mural / Supporto a parete asciugatrice für EU und USA Version erhältlich / available for EU and USA version disponible pour les versions UE et USA / disponibile per la versione EU e USA
--------	--





## WERBEMITTEL

ADVERTISING MATERIAL / MATÉRIEL DE PUBLICITÉ / MATERIALE PUBBLICITARIO



### MONTANA – «SERVICE»-FALTPROSPEKT

“Service“-leaflet / «Service»-dépliant / Dépliant a fisarmonica «Manutenzione»

6 Seiten Rückseite personalisiert mit Ihrem Logo

6 pages Personalized back side with your company logo

6 pages Le dos peut être personnalisé avec votre logo

6 pagini Retro personalizzato con il suo logo

110 x 70 mm

Preis auf Anfrage / Price on request / Prix sur demande / Prezzo su richiesta

### MONTANA – SPANNBAND

Banner / Banière / Bandiera

Witterungsbeständiger Kunststoff, individuell angepasst mit Ihrem Firmenlogo

Weather-resistant plastic, personalized with your company logo

Matière plastique robuste, personnalisé avec votre logo

Plastica resistente agli agenti atmosferici, personalizzabile con il vostro logo aziendale

Preis auf Anfrage / Price on request / Prix sur demande / Prezzo su richiesta

### MONTANA – WERBETAFELN

Advertising panel / Tableau publicitaire / Cartelloni

Design nach Ihren Vorgaben und mit Ihrem Logo

Design according to your instructions with your logo

Design d'après vos indications avec votre logo

Creata secondo le vostre indicazioni e con il vostro logo

Preis auf Anfrage / Price on request / Prix sur demande / Prezzo su richiesta

### CRYSTAL GLIDE FINISH – SKISERVICE-KLEBER

Skiservice sticker / Autocollant skiservice / Adesivo per manutenzione di sci

Druck anthrazit auf silber mit Ihrem Logo

Anthracite print on silver foil with your logo

Imprimé anthracite sur support argent avec votre logo

Stampa antracite su base argento con il vostro logo

33 x 45 mm

Preis auf Anfrage / Price on request / Prix sur demande / Prezzo su richiesta

### LEUCHTREKLAME INDIVIDUELL «BLAU»

Illuminated advertising individual «blue»

Panneau lumineux individuel «bleu»

Segnale luminoso individuale «blu»

gute Logo Auflösung erforderlich

good logo resolution required

bonne résolution du logo demandée

buona risoluzione del logo richiesto

\* 700022

ab / from / à partir de / a partire da

### MONTANA – BEACHFLAG

Hochwertige Ausführung, witterungsbeständiger Druck, inkl. Mast und Bodenplatte.

Gesamthöhe ca. 230 cm, individuelles Design möglich.

High-grade flag, weather-resistant print, customized design possible,

height approx. 230 cm.

Drapeau de haute qualité, imprimé permanent et résistant, avec mât et plaque

de fond, design individuel possible, hauteur env. 230 cm.

Versione pregiata, stampa resistente agli agenti atmosferici, con incluso palo e piastra di base.

Altezza completa ca. 230 cm, design individuale possibile.

Preis auf Anfrage / Price on request / Prix sur demande / Prezzo su richiesta

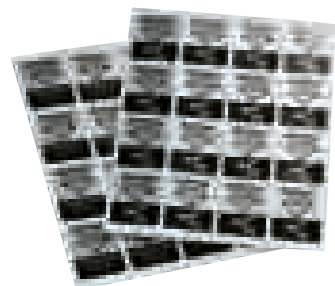

## WERBEMITTEL

ADVERTISING MATERIAL / MATÉRIEL DE PUBLICITÉ / MATERIALE PUBBLICITARIO



### MONTANA USB STICK – SLIM

\* 700037 8 GB



### MONTANA – PRODIR DS8 KUGELSCHREIBER

MONTANA pen  
MONTANA stylo  
MONTANA penna

\* 700038 100 Stück / piece / pièce / pezzo



### MONTANA SKINS PORTEMONNAIE

MONTANA SKINS wallet  
Porte-monnaie MONTANA SKINS  
Portafoglio MONTANA SKINS

\* 700061 11.5cm x 8cm

\* Erhältlich in den Designs / \* Available in the following designs A, B, C, D, E, F, G, H, I

\* Disponible dans les designs / \* Disponibile nei modelli A, B, C, D, E, F, G, H, I



### MONTANA SKINS GURT

MONTANA SKINS belt  
Ceinture MONTANA SKINS  
Cintura MONTANA SKINS

\* 700062 115cm x 130cm x 3.8cm

\* Erhältlich in den Designs / \* Available in the following designs A, B, C, D, E, F, G, H, I, J, K

\* Disponible dans les designs / \* Disponibile nei modelli A, B, C, D, E, F, G, H, I, J, K



### MONTANA SKINS EINKAUFSTASCHE

MONTANA SKINS bag  
Sac à provisions MONTANA SKINS  
Borsa per la spesa MONTANA SKINS

\* 700060 36cm x 47cm x 12cm

\* Erhältlich in den Designs / \* Available in the following designs A, B, C, D, E, F, G, H, I

\* Disponible dans les designs / \* Disponibile nei modelli A, B, C, D, E, F, G, H, I

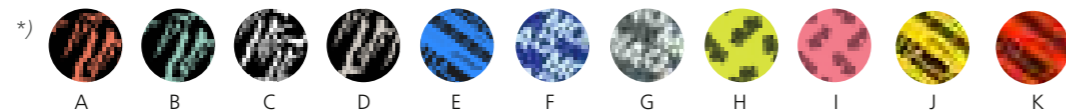

## SKICLICHER & BOOT BIB

DIE LÖSUNG FÜR EINEN SCHNELLEREN VERLEIHABLAUF / THE SOLUTION FOR FASTER RENTAL PROCESSES  
LA SOLUTION POUR UNE LOCATION PLUS RAPIDE / LA SOLUZIONE PER RAPIDE OPERAZIONI DI NOLEGGIO

### SKICLICHER - SOLE JUNIOR FÜR EINEN SCHNELLEREN VERLEIHABLAUF

The solution for faster rental processes

La solution pour une location plus rapide

La soluzione per rapide operazioni di noleggio

110215	SkiClicker - Sole Junior	200 - 300 mm
110761	SkiClicker 2.0 - Sole Senior	250 - 355 mm
110910	SkiClicker Tech ATK	255 - 355 mm



### BOOT ANALYZER ERFASST SCHNELLSTENS IHREN SKISCHUH-BESTAND

BOOT ANALYZER quickly records your ski boot inventory

BOOT ANALYZER enregistre en un temps record votre stock de chaussures de ski

BOOT ANALYZER rileva il più velocemente possibile il vostro rifornimento di scarponi da sci

110217 Boot Analyzer



### BOOT BIB DER SKISCHUH - ANZIEHER

The ski boot horn

Il calzascarpone da sci

Chausse - piedpour chaussures de ski

110298	BOOT BIB „Junior“ MONTANA Design
110299	BOOT BIB „Senior“ MONTANA Design
110307	BOOT BIB „Junior“ GOOGLE Design
110308	BOOT BIB „Senior“ GOOGLE Design
110309	BOOT BIB „Junior“ BEAR Design
110310	BOOT BIB „Senior“ BEAR Design



### EIGENES LOGO AUF ANFRAGE / YOUR LOGO ON REQUEST

VOTRE LOGO SUR DEMANDE / LOGO PERSONALE SU RICHIESTA



# MONTANA BEKLEIDUNG

MONTANA APPAREL / VÊTEMENTS MONTANA / ABBIGLIAMENTO MONTANA



## MONTANA – HOME OF SKISERVICE

100 % Baumwolle / cotton / coton / cotone

mit Print auf Brust / with print on chest / avec une impression sur la poitrine  
con stampa su petto

\*700045 Damen / Ladys / Femmes / Donne XS, S, M, L, XL

\*700044 Herren / Men / Hommes / Uomini S, M, L, XL, 2XL, 3XL



## HOODIE – HOME OF SKISERVICE

57% Polyester 43% Baumwolle / cotton / coton / cotone

mit Print auf Brust und Ärmel / with print on chest and sleeves / avec une impression sur  
la poitrine et les manches / con stampa su petto e sulle maniche

\*700049 Damen / Ladys / Femmes / Donne XS, S, M, L, XL

\*700050 Herren / Men / Hommes / Uomini S, M, L, XL



## THE WORLD OF EXCELLENCE - T-SHIRT

100 % Biobaumwolle / organic cotton / coton bio / cotone biologico

mit Print auf Brust und Rücken / printed on the chest and back  
avec imprimé sur la poitrine et le dos / con stampa sul petto e sulla schiena

schwarz / black / noir / nero

\*700041 S, M, L, XL, 2XL



## MONTANA LONGSLEEVE

100 % Biobaumwolle / organic cotton / coton bio / cotone biologico

mit Print auf Brust / With print on the chest / Avec impression sur la poitrine / Con stampa sul petto  
royal blau / royal blau / bleu royal / blu reale

\*700080 Herren / Men / Hommes / Uomini S, M, L, XL, 2XL, 3XL

## STRICKMÜTZE

100% Polycryl

inkl. woven label

schwarz / black / noir / nero

\*700046 one size



## MONTANA – CAP

6 Panel-Cap quick dry

mit gewobenem Label / with woven label / avec étiquette tissée / con etichetta tessuta

\*700047 schwarz / black / noir / nero



## FUSIONTEC HEADBAND

100% Polyester

inkl. Sublimationsdruck und Weblabel / including sublimation print  
une impression par sublimation incluse / compresa la stampa a sublimazione

\*700048 schwarz, grau / black, grey / noir, gris / nero, grigio

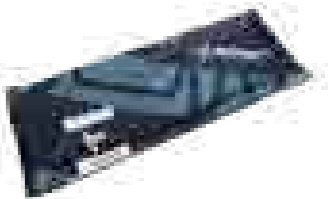

## FUSIONTEC HEADBAND

100 % Polyester

inkl. Sublimationsdruck und Weblabel / including sublimation print  
une impression par sublimation incluse / compresa la stampa a sublimazione

\*700051 rot, schwarz / red, black / rouge, noir / rosso, nero



## MONTANA - UMBRELLA

Automatische Öffnung/Schliessung / Automatic opening/closing  
Ouverture/fermeture automatique / Apertura/chiusura automatica

Stockschirm mit grossem MONTANA Druck / Umbrella with large MONTANA print  
Parapluie avec grande impression MONTANA / Ombrello a bastone con grande stampa MONTANA

\*110945 schwarz / black / noir / nero



**MONTANA**<sup>®</sup>   
skins



# STEIGFELLE VON MONTANA

CLIMBING SKINS FROM MONTANA / PEaux DE MONTÉE DE MONTANA / PELLI DI FOCA MONTANA



## MONTARACE HIGH SPEED

100% Mohair

Der Supersteiger unter den Rennfellen  
The super climb among racing skins  
Les peaux de compétition pour une escalade d'enfer  
Il super scalatore tra le pelli da gara



## MONTARACE SUPER GLIDE

100% Mohair

Der Supergleiter unter den Rennfellen  
The super glide among racing skins  
Les peaux de compétition pour une glisse d'enfer  
Il super slider tra le pelli da gara



## MONTASPRINT ADRENALINE WITH FUSIONTEC ADHESION

100% Mohair

Das schnelle Steigfell mit besonders langer Ausdauer  
The fast climbing skin with extra long endurance  
La peau de phoque rapide avec une endurance particulièrement longue  
La pelliccia che si arrampica velocemente con una resistenza extra lunga



## MONTASPRINT

100% Mohair

Das schnelle Steigfell mit besonders langer Ausdauer  
The fast climbing skin with extra long endurance  
La peau de phoque rapide avec une endurance particulièrement longue  
La pelliccia che si arrampica velocemente con una resistenza extra lunga



## MONTAMIX ADRENALINE WITH FUSIONTEC ADHESION

65% Mohair / 35% Nylon

Das robuste Allrounder-Steigfell mit der einzigartigen FUSIONTEC Adhäsion  
The robust all-rounder climbing skin with the unique FUSIONTEC adhesion  
The robust all-rounder climbing skin with the unique FUSIONTEC adhesion  
La robusta pelli di foca tuttofare con l'esclusiva adesione FUSIONTEC

## MONTAMIX

65% Mohair / 35% Nylon

Das robuste Allrounder-Steigfell für alle Schneearten  
The robust all-rounder climbing skin for all types of snow  
La peau de phoque robuste et polyvalente pour tous les types de neige  
La robusta pelli di foca tuttofare per tutti i tipi di neve



## MONTAMIX

65% Mohair / 35% Nylon

Das robuste Allrounder-Steigfell für alle Schneearten  
The robust all-rounder climbing skin for all types of snow  
La peau de phoque robuste et polyvalente pour tous les types de neige  
La robusta pelli di foca tuttofare per tutti i tipi di neve



## MONTANYL

100% Nylon

Das hochrobuste Steigfell für eine lange Lebensdauer  
The highly durable climbing skin for a long life  
La peau de phoque ultra-résistante pour une longue durée de vie  
La pelli di foca altamente resistente per una lunga durata



! Die Preise der verschiedenen Fellqualitäten und Befestigungsvarianten finden Sie in der Preisliste  
The prices of the different skin qualities and mounting options can be found in the price list  
Vous trouverez dans la liste les prix des diverses qualités de peau ainsi que des différentes variantes de fixation  
Troverete i prezzi delle diverse qualità di pelli e varianti di fissaggio nel listino prezzi

## PFLEGE & ZUBEHÖR

CARE & ACCESSORIES / SOIN & ACCESSOIRES / CURA & ACCESSORI



### GLIDE PLUS

125 ml

109790 Stück / piece / pièce / pezzo 6er A



### IMPRÄGNIERWACHS

Impregnating wax / fart d'imprégnation/ impregnante a cera

107980 Stück / piece / pièce / pezzo 2x 35gr. A



### KLEBER-TUBE

Adhesive / Colle / Adesivo

108033 Stück / piece / pièce / pezzo 75 ml



### TRANSFER-KLEBEROLLE ZUR NEUBESCHICHTUNG

Glue-on transfer tape to renew the glue

Colle sur feuille de transfer pour renouveler la colle

Rullo adesivo transfer per rivestimento

108268 Rolle / reel / rouleau / rullo 160 mm x 50 m

107494 Rolle / reel / rouleau / rullo 120 mm x 50 m

108267 Rolle / reel / rouleau / rullo 160 mm x 4 m

108000 Rolle / reel / rouleau / rullo 120 mm x 4 m

### NACHBESCHICHTUNG

Re-glue the skins / Réencoller des peaux / Nuovo rivestimento

MONTANA Felle / skins / peaux / pelli di foca

300500



### HOBBY LÖTKOLBEN

Ohne Spachteleinsatz

Without spatula attachment

Fer à souder sans spatule pour les loisirs

Saldatore per hobbistica senza attacco per spatola

108048 Stück / piece / pièce / pezzo 1 x 230 V, 100 Watt

### PROFI LÖTKOLBEN

Ohne Spachteleinsatz

Without spatula attachment

Fer à souder sans spatule pour les loisirs

Saldatore per hobbistica senza attacco per spatola

109875 Stück / piece / pièce / pezzo 1 x 230 V, 100 Watt

### SPACHTELEINSATZ

Spatula to remove the glue

Spatule pour enlever la colle

Attacco per spatola

102489 Stück / piece / pièce / pezzo 100 mm

### FELLTASCHE

Climbing skin bag / Sac pour peaux / Borsa per pelli di foca

109322 Stück / piece / pièce / pezzo

### SKINNY

Paar / pair / paire / paia

108044 70 x 19 cm

### SCHUTZNETZ

Filet de protection / Protection net / Rete di protezione

109892 Meter / meter / mètre / metro 90 mm

108972 Meter / meter / mètre / metro 140 mm

108973 Meter / meter / mètre / metro 170 mm

110344 2x1 Meter / meter / mètre / metro 90 mm

110345 2x1 Meter / meter / mètre / metro 140 mm

110346 2x1 Meter / meter / mètre / metro 170 mm

### ZUSCHNEIDEMESSER

Cutting knife – Edge-free cutting / Cutter de découpe – Découpe sans arêtes

Set da taglio – Per un taglio fluido senza bordi

108988 Stück / piece / pièce / pezzo

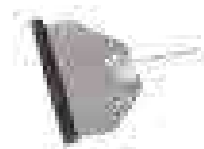

## PFLEGE & ZUBEHÖR

CARE & ACCESSORIES / SOIN & ACCESSOIRES / CURA & ACCESSORI

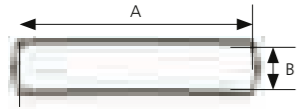

<b>FELLBÜGEL</b>			
Skin bracket / Étrier / Staffa per pelle			
108484	21 x 18 x 3 mm (Skipiercing)	Paar / pairs / paires / paia	
108479	A = 29 mm / B = 9 mm	Paar / pairs / paires / paia	
108480	A = 40 mm / B = 9 mm	Paar / pairs / paires / paia	
108481	A = 52 mm / B = 9 mm	Paar / pairs / paires / paia	
108485	A = 60 mm / B = 12 mm	Paar / pairs / paires / paia	
108053	A = 65 mm / B = 22 mm	Paar / pairs / paires / paia	A
108161	A = 69 mm / B = 11 mm	Paar / pairs / paires / paia	A
108051	A = 82 mm / B = 11 mm	Paar / pairs / paires / paia	
108049	A = 94 mm / B = 11 mm	Paar / pairs / paires / paia	
108052	A = 109 mm / B = 11 mm	Paar / pairs / paires / paia	

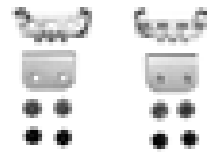

<b>SKI CLAMP SET</b>		
Mit Metall-Laschen und Nieten / With metal platelets and rivets Avec languettes métalliques et rivets / Con linguetta metallica e rivetti		
109366	19 x 22 mm	Set



<b>U-HOOK SET</b>		
Mit Metall-Laschen und Nieten / With metal platelets and rivets Avec languettes métalliques et rivets / U-Hook con linguetta metallica e rivetti		
110089	19 x 22 mm	Set



<b>Z-HOOK SET</b>		
Mit Metall-Laschen und Nieten / With metal platelets and rivets Avec languettes métalliques et rivets / U-Hook con linguetta metallica e rivetti		
110091	19 x 22 mm	Set

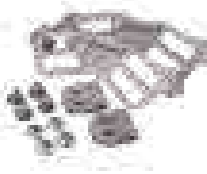

<b>SPLITCLAMP SET</b>		
Mit Metall-Laschen und Nieten / With metal platelets and rivets Avec languettes métalliques et rivets / U-Hook con linguetta metallica e rivetti		
110094	19 x 22 mm	Set



<b>METALL-LASCHEN SET</b>		
Metall-Laschen mit Nieten / Metal platelets with rivets Languettes métalliques et rivets / Linguetta metallica con rivetti		
107829	58 x 28 mm	Set

<b>METALL-LASCHEN SET</b>		
Metall-Laschen mit Nieten / Metal platelets with rivets Languettes métalliques et rivets / Linguetta metallica con rivetti		
110148	30 x 22 mm	Set

<b>METALL-LASCHEN SET SCHMAL</b>		
With rivets, narrow/ Languettes métalliques et rivets, modèle fin Linguetta metallica con rivetti		
110109	19 x 22 mm	Set

<b>U-HOOK SET</b>		
Mit Gummiband und Nieten / With elastic band and rivets Avec bande élastique et rivets / U-Hook con elastico e rivetti		
110090	205 mm	Set kurz / Short set / Set court / Set corto
110347	275 mm	Set lang / Long set / Set long / Set lungo

<b>TWINTIP SET</b>		
Mit Gummiband und Nieten / With elastic band and rivets Avec bande élastique et rivets / Twintip con elastico e rivetti		
110092	205 mm	Set kurz / Short set / Set court / Set corto
110348	275 mm	Set lang / Long set / Set long / Set lungo

<b>SPLIT CLAMP SET</b>		
Mit Gummiband und Nieten / With elastic band and rivets Avec bande élastique et rivets / Twintip con elastico e rivetti		
109368	205 mm	Set kurz / Short set / Set court / Set corto
110349	275 mm	Set lang / Long set / Set long / Set lungo

<b>TAIL CLIP SET</b>		
Mit Gummiband und Nieten / With elastic band and rivets Avec bande élastique et rivets / Twintip con elastico e rivetti		
107954	205 mm	Set kurz / Short set / Set court / Set corto
110350	275 mm	Set lang / Long set / Set long / Set lungo

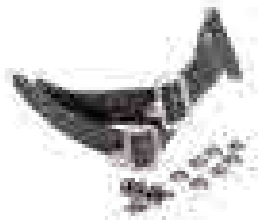
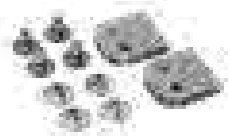
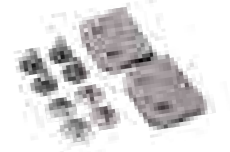

## PFLEGE & ZUBEHÖR

CARE & ACCESSORIES / SOIN & ACCESSOIRES / CURA & ACCESSORI



### TAIL CLIP

108064 Paar / pairs / paires / paia

### TWINTIP CLAMP INOX

110093 1 Paar / pairs / paires / paia

### SPLIT CLAMP

108666 Paar / pairs / paires / paia

### TUBULARNIETEN

Tubular rivets / rivets / Rivetti tubolari

102511 Set à 100

### RACE SET

109610 58 x 28 mm





# VERBRAUCHSMATERIAL

MACHINE CONSUMABLES / MATÉRIAUX DE CONSOMMATION / MATERIALE DI CONSUMO

## CRYSTAL MAGIC



## CRYSTAL ROCK



## CRYSTAL ONYX

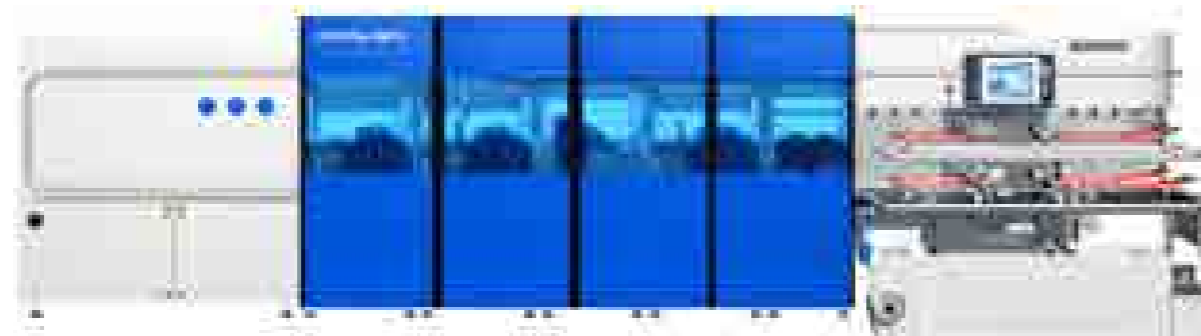

## CRYSTAL MAGIC

109313	Schleifring blau	Grinding ring blue	Anneau de ponçage bleu	Anello di rettifica blu	350 x 320 x 152 mm	A-36/KK10P
109464	Schleifring blau	Grinding ring blue	Anneau de ponçage bleu	Anello di rettifica blu	350 x 340 x 152 mm	A-36/KK10P
109525	Schleifring braun	Grinding ring brown	Anneau de ponçage brun	Anello di rettifica marrone	350 x 320 x 152 mm	E-30/2/7LP
107617	Schleifring braun	Grinding ring brown	Anneau de ponçage brun	Anello di rettifica marrone	350 x 340 x 152 mm	E-30/2/7L
107538	Abrichtwerkzeug Stein	Dressing tool stone	Outil de dressage meule	Utensile di rettifica pietra		K320 LF
	Abrichtwerkzeug Plexi ohne Grundplatte	Dressing tool plexi without base plate	Outil de dressage plexi sans plaque de base	Utensile di rettifica pietra plexi senza base	320 mm	
109413	Schleifband	Sanding belt	Bande abrasive	Nastro abrasivo	50 x 1340 mm	K240
109414	Schleifband	Sanding belt	Bande abrasive	Nastro abrasivo	50 x 1340 mm	K320
109370	Tuning-Scheibe rot	Tuning disc red	Disque de tuning rouge	Disco tuning rosso	250 x 50 x 152 mm	
109078	Tuning-Scheibe rot	Tuning disc red	Disque de tuning rouge	Disco tuning rosso	350 x 60 x 203 mm	
109524	Tuning-Scheibe mittel	Tuning disc medium	Disque de tuning medium	Disco tuning medio	250 x 50 x 152 mm	
108707	Tuning-Scheibe mittel	Tuning disc medium	Disque de tuning medium	Disco tuning medio	350 x 60 x 203 mm	
109545	Schleifband	Sanding belt	Bande abrasive	Nastro abrasivo	CU II	K150
109546	Schleifband	Sanding belt	Bande abrasive	Nastro abrasivo	CU II	K180
109570	Schleifband	Sanding belt	Bande abrasive	Nastro abrasivo	Trizact	A65
109569	Schleifband	Sanding belt	Bande abrasive	Nastro abrasivo	Trizact	A100
107682	Abrichtwerkzeug HTT	Dressing tool HTT	Outil de dressage HTT	Utensile di rettifica HTT		PW-V1555 LF
109436	Abrichtwerkzeug HTT PRO	Dressing tool HTT PRO	Outil de dressage HTT PRO	Utensile di rettifica HTT PRO		PW-V 1885 RM
106547	Wachs gelb	Wax yellow	Fart jaune	Sciolina gialla		2.6kg (2 x 1300g)
107298	Wachs grün	Wax green	Fart vert	Sciolina verde		2.6kg (2 x 1300g)
107817	Wachs -und Polierbürste	Roll-brush for waxing and polishing	Brosse pour fartage et polissage	Spazzola per sciolinatura e lucidatura		
106470	Filterrolle	Filter roll	Rouleau de filtre	Rullo filtrante	1000 x 100 mm	T12
109015	WinTheRace	WinTheRace	WinTheRace	WinTheRace	1000 ml	K320 LF
106385	Schleifemulsion	Sanding emulsion	Emulsion de ponçage	Emulsione per rettifiche	25 lt	V3

## CRYSTAL ROCK

109313	Schleifring blau	Grinding ring blue	Anneau de ponçage bleu	Anello di rettifica blu	350 x 320 x 152 mm	A-36/KK10P
109464	Schleifring blau	Grinding ring blue	Anneau de ponçage bleu	Anello di rettifica blu	350 x 340 x 152 mm	A-36/KK10P
107538	Abrichtwerkzeug Stein	Dressing tool stone	Outil de dressage meule	Utensile di rettifica pietra		K320 LF
	Abrichtsystem Plexi ohne Grundplatte	Dressing system plexi without base plate	Système de dressage plexi sans plaque de base	Sistema di rettifica pietra plexi senza base	320 mm	
109413	Schleifband	Sanding belt	Bande abrasive	Nastro abrasivo	50 x 1340 mm	K240
109414	Schleifband	Sanding belt	Bande abrasive	Nastro abrasivo	50 x 1340 mm	K320
109545	Schleifband	Sanding belt	Bande abrasive	Nastro abrasivo	CU II	K150
109546	Schleifband	Sanding belt	Bande abrasive	Nastro abrasivo	CU II	K180
109570	Schleifband	Sanding belt	Bande abrasive	Nastro abrasivo	Trizact	A65
109569	Schleifband	Sanding belt	Bande abrasive	Nastro abrasivo	Trizact	A100
105594	Tuning-Scheibe mittel	Tuning disc medium	Disque de tuning medium	Disco tuning medio	230 x 50 x 152 mm	
109080	Tuning-Scheibe rot	Tuning disc red	Disque de tuning rouge	Disco tuning rosso	230 x 50 x 152 mm	
107682	Abrichtwerkzeug HTT	Dressing tool HTT	Outil de dressage HTT	Utensile di rettifica HTT		PW-V1555 LF
101889	Filterrolle	Filter roll	Rouleau de filtre	Rullo filtrante	540 x 100 mm	T12
104929	Filterstrumpf (Box)	Nylon filter (box)	Filtre nylon (boîte)	Base filtrante in nylon (box)	40 m	
106385	Schleifemulsion	Emulsion de ponçage	Emulsion de ponçage	Emulsione per rettifiche	25 lt	V3

## CRYSTAL ONYX

108704	Schleifring orange	Grinding ring orange	Anneau de ponçage orange	Anello di rettifica arancio	350 x 180 x 203 mm	A-36/LB
107681	Abrichtwerkzeug Stein	Dressing tool stone	Outil de dressage meule	Utensile di rettifica pietra		K125 LF
	Abrichtsystem Plexi ohne Grundplatte	Dressing system plexi without base plate	Système de dressage plexi sans plaque de base	Sistema di rettifica pietra plexi senza base	180 mm	
108523	Schleifband	Sanding belt	Bande abrasive	Nastro abrasivo	50 x 1340 mm	K240
109414	Schleifband	Sanding belt	Bande abrasive	Nastro abrasivo	50 x 1340 mm	K320
109545	Schleifband	Sanding belt	Bande abrasive	Nastro abrasivo	CU II	K150
109546	Schleifband	Sanding belt	Bande abrasive	Nastro abrasivo	CU II	K180
109570	Schleifband	Sanding belt	Bande abrasive	Nastro abrasivo	Trizact	A65
109569	Schleifband	Sanding belt	Bande abrasive	Nastro abrasivo	Trizact	A100
108708	Tuning-Scheibe blau	Tuning disc blue	Disque de tuning bleu	Disco tuning blu	350 x 70 x 203 mm	
107682	Abrichtwerkzeug HTT	Dressing tool HTT	Outil de dressage HTT	Utensile di rettifica HTT		PW-V1555 LF
109437	Wachs gelb	Wax yellow	Fart jaune	Sciolina gialla	178 x 25 x 164 mm	
109438	Wachs grün	Wax green	Fart vert	Sciolina verde	178 x 25 x 164 mm	K 80
109439	Wachs-Bürste	Roll-brush for waxing	Brosse pour fartage	Spazzola per sciolinatura	150 x 60 x 190 mm	K 120
109440	Polier-Bürste	Roll-brush for polishing	Brosse pour polissage	Spazzola per lucidatura	151 x 60 x 190 mm	
106515	Filterrolle	Filter roll	Rouleau de filtre	Rullo filtrante	750 mm x 100 m	T12
106385	Schleifemulsion	Sanding emulsion	Emulsion de ponçage	Emulsione per rettifiche	25 lt	V3

# VERBRAUCHSMATERIAL

MACHINE CONSUMABLES / MATÉRIAUX DE CONSOMMATION / MATERIALE DI CONSUMO

## BLUE PEARL

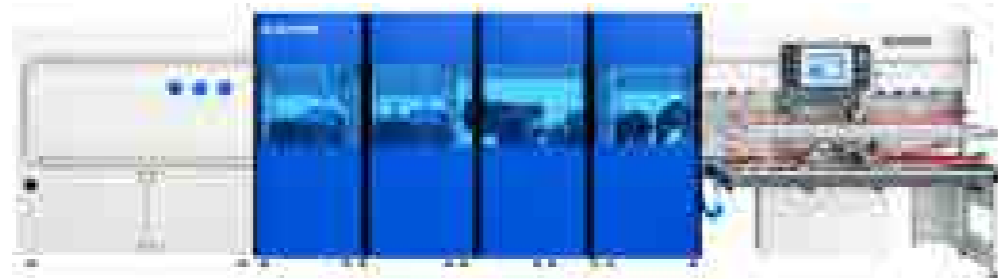

## SAPHIR / SAPHIR PRO



## DIAMOND



## MODULAR ENERGY

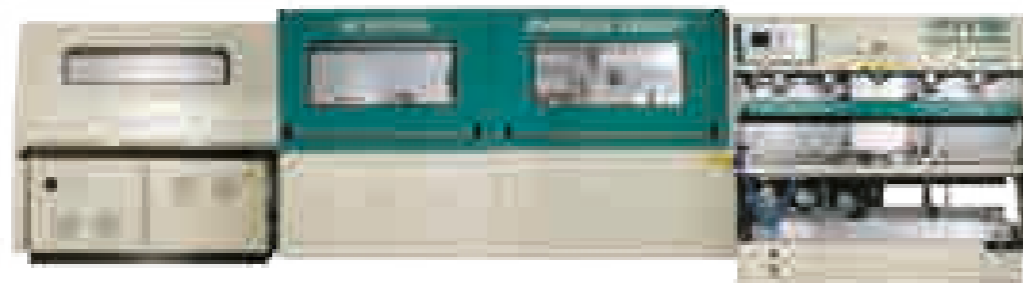

## BLUE PEARL / SAPHIR / SAPHIR PRO

109313	Schleifring blau	Grinding ring blue	Anneau de ponçage bleu	Anello di rettifica blu	350 x 320 x 152 mm	A-36/KK10P
109464	Schleifring blau	Grinding ring blue	Anneau de ponçage bleu	Anello di rettifica blu	350 x 340 x 152 mm	A-36/KK10P
109525	Schleifring braun	Grinding ring brown	Anneau de ponçage brun	Anello di rettifica marrone	350 x 320 x 152 mm	E-30/2/7LP
107617	Schleifring braun	Grinding ring brown	Anneau de ponçage brun	Anello di rettifica marrone	350 x 340 x 152 mm	E0/2/7L
107538	Abrichtwerkzeug Stein	Dressing tool stone	Outil de dressage meule	Utensile di rettifica pietra		K 320 LF
107599	Abrichtsystem Plexi ohne Grundplatte	Dressing system plexi without base plate	Dresseur système en plexi sans plaque de base	Sistema di rettifica plexi senza base	320 mm	
101889	Filterrolle	Filter roll	Rouleau de filtre	Rullo filtrante	540 mm x 100 m	T 12
106515	Filterrolle (1 Stein)	Filter roll (1 stone)	Rouleau de filtre (1 meule)	Rullo filtrante (1 pietra)	750 mm x 100 m	T 12
106470	Filterrolle (2 Steine)	Filter roll (2 stones)	Rouleau de filtre (2 meules)	Rullo filtrante (2 pietre)	1000 mm x 100 m	T 12
101833	Schleifband	Sanding belt	Bande abrasive	Nastro abrasivo	30 x 1340 mm	K 80
101834	Schleifband	Sanding belt	Bande abrasive	Nastro abrasivo	30 x 1340 mm	K 100
101835	Schleifband	Sanding belt	Bande abrasive	Nastro abrasivo	30 x 1340 mm	K 120
105594	Tuning-Scheibe mittel	Tuning disc medium	Disque de tuning medium	Disco tuning medio	230 x 50 x 152 mm	
107682	Abrichtwerkzeug HTT	Dressing tool HTT	Outil de dressage HTT	Utensile di rettifica HTT		PW-V1555 LF
106547	Wachs gelb	Wax yellow	Fart jaune	Sciolina gialla	2.6 kg (2 x 1300 g)	
107298	Wachs grün	Wax green	Fart vert	Sciolina verde	2.6 kg (2 x 1300 g)	
106337	Wachs-Bürste	Roll-brush for waxing	Brosse pour fartage	Spazzola per sciolinatura		
106336	Polier-Bürste	Roll-brush for polishing	Brosse pour polissage	Spazzola per lucidatura		
106385	Schleifemulsion	Emulsion de ponçage	Sanding emulsion	Emulsione per rettifiche	25 lt	V3

## DIAMOND

106181	Schleifring	Grinding ring	Anneau de ponçage	Anello di rettifica	350 x 160 x 203 mm	A 36/LB
106182	Schleifring	Grinding ring	Anneau de ponçage	Anello di rettifica	350 x 160 x 203 mm	E 30/1/7
107682	Abrichtwerkzeug HTT	Dressing tool HTT	Outil de dressage HTT	Utensile di rettifica HTT		PW-V1555 LF
107681	Abrichtwerkzeug Stein	Dressing tool stone	Outil de dressage meule	Utensile di rettifica pietra		K 125 LF
108522	Abrichtsystem Plexi ohne Grundplatte	Dressing system plexi without base plate	Dresseur système en plexi sans plaque de base	Sistema di rettifica plexi senza base	160 mm	
106515	Filterrolle	Filter roll	Rouleau de filtre	Rullo filtrante	750 mm x 100 m	T 12
101889	Filterrolle	Filter roll	Rouleau de filtre	Rullo filtrante	540 mm x 100 m	T 12
101833	Schleifband	Sanding belt	Bande abrasive	Nastro abrasivo	30 x 1340 mm	K 80
101834	Schleifband	Sanding belt	Bande abrasive	Nastro abrasivo	30 x 1340 mm	K 100
101835	Schleifband	Sanding belt	Bande abrasive	Nastro abrasivo	30 x 1340 mm	K 120
108175	Tuning-Scheibe mittel	Tuning disc medium	Disque de tuning medium	Disco tuning medio	300 x 60 x 145 mm	
106088	Wachs gelb	Wax yellow	Fart jaune	Sciolina gialla	1 kg (4 x 250 g)	
106089	Wachs grün	Wax green	Fart vert	Sciolina verde	1 kg (4 x 250 g)	
106090	Wachs blau	Wax blue	Fart bleu	Sciolina blu	1 kg (4 x 250 g)	
104889	Wachs-Bürste	Roll-brush for waxing	Brosse pour fartage	Spazzola per sciolinatura		
104890	Polier-Bürste	Roll-brush for polishing	Brosse pour polissage	Spazzola per lucidatura		
106385	Schleifemulsion	Sanding emulsion	Emulsion de ponçage	Emulsione per rettifiche	25 lt	V3

## MODULAR ENERGY

105231	Schleifring	Grinding ring	Anneau de ponçage	Anello di rettifica	350 x 135 x 203 mm	A 36/LB
101923	Schleifring	Grinding ring	Anneau de ponçage	Anello di rettifica	350 x 135 x 203 mm	E 30/1/7
106181	Schleifring	Grinding ring	Anneau de ponçage	Anello di rettifica	350 x 160 x 203 mm	A 36/LB
106182	Schleifring	Grinding ring	Anneau de ponçage	Anello di rettifica	350 x 160 x 203 mm	E 30/1/7
107681	Abrichtwerkzeug Stein	Dressing tool stone	Outil de dressage meule	Utensile di rettifica pietra		K 125 LF
102017	Abrichtholz	Wooden block	Bois de dressage	Legno di rettifica	135 mm	
108522	Abrichtsystem Plexi ohne Grundplatte	Dressing system plexi without base plate	Dresseur système en plexi sans plaque de base	Sistema di rettifica plexi senza base	160 mm	
101889	Filterrolle	Filter roll	Rouleau de filtre	Rullo filtrante	540 mm x 100 m	T 12
101833	Schleifband	Sanding belt	Bande abrasive	Nastro abrasivo	30 x 1340 mm	K 80
101834	Schleifband	Sanding belt	Bande abrasive	Nastro abrasivo	30 x 1340 mm	K 100
101835	Schleifband	Sanding belt	Bande abrasive	Nastro abrasivo	30 x 1340 mm	K 120
105628	Tuning-Scheibe mittel	Tuning disc medium	Disque de tuning medium	Disco tuning medio	300 x 50 x 152 mm	
108175	Tuning-Scheibe mittel	Tuning disc medium	Disque de tuning medium	Disco tuning medio	300 x 60 x 145 mm	
107682	Abrichtwerkzeug HTT	Dressing tool HTT	Outil de dressage HTT	Utensile di rettifica HTT		PW-V1555 LF
106088	Wachs gelb	Wax yellow	Fart jaune	Sciolina gialla	1 kg (4 x 250 g)	
106089	Wachs grün	Wax green	Fart vert	Sciolina verde	1 kg (4 x 250 g)	
106090	Wachs blau	Wax blue	Fart bleu	Sciolina blu	1 kg (4 x 250 g)	
104889	Wachs-Bürste	Roll-brush for waxing	Brosse pour fartage	Spazzola per sciolinatura		
104890	Polier-Bürste	Roll-brush for polishing	Brosse pour polissage	Spazzola per lucidatura		
106385	Schleifemulsion	Sanding emulsion	Emulsion de ponçage	Emulsione per rettifiche	25 lt	V3

# VERBRAUCHSMATERIAL

MACHINE CONSUMABLES / MATÉRIAUX DE CONSOMMATION / MATERIALE DI CONSUMO

CRYSTAL ONE



CRYSTAL RACE

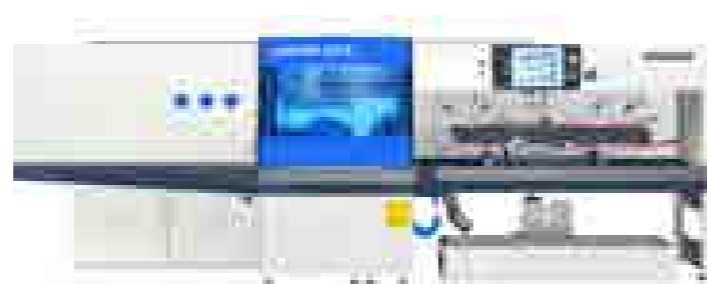

CHALLENGE



SNOW CRUISER



MAS 2000 PS



TWISTER 8



SNOW STAR



## CRYSTAL ONE / RACE

106181	Schleifring	Grinding ring	Anneau de ponçage	Anello di rettifica	350 x 160 x 203 mm	A-36/LB
108704	Schleifring	Grinding ring	Anneau de ponçage	Anello di rettifica	350 x 180 x 203 mm	A-36/LB
108705	Schleifring	Grinding ring	Anneau de ponçage	Anello di rettifica	350 x 200 x 203 mm	A-36/LB
107538	Abrichtwerkzeug Stein	Dressing tool stone	Outil de dressage meule	Utensile di rettifica pietra		K 320 LF
108522	Abrichtsystem Plexi ohne Grundplatte	Dressing system plexi without base plate	Dresseur système en plexi sans plaque de base	Sistema di rettifica plexi senza base	160 mm	
108523	Abrichtsystem Plexi ohne Grundplatte	Dressing system plexi without base plate	Dresseur système en plexi sans plaque de base	Sistema di rettifica plexi senza base	180 mm	
108524	Abrichtsystem Plexi ohne Grundplatte	Dressing system plexi without base plate	Dresseur système en plexi sans plaque de base	Sistema di rettifica plexi senza base	200 mm	
101830	Schleifband	Sanding belt	Bande abrasive	Nastro abrasivo	30 x 910 mm	K 80
101831	Schleifband	Sanding belt	Bande abrasive	Nastro abrasivo	30 x 910 mm	K 100
109413	Schleifband	Sanding belt	Bande abrasive	Nastro abrasivo	50 x 1340 mm	K240
109414	Schleifband	Sanding belt	Bande abrasive	Nastro abrasivo	50 x 1340 mm	K320
109545	Schleifband	Sanding belt	Bande abrasive	Nastro abrasivo	CU II 50 x 1340 mm	K150
109546	Schleifband	Sanding belt	Bande abrasive	Nastro abrasivo	CU II 50 x 1340 mm	K180
109570	Schleifband	Sanding belt	Bande abrasive	Nastro abrasivo	Trizact 50 x 1340 mm	A65
109569	Schleifband	Sanding belt	Bande abrasive	Nastro abrasivo	Trizact 50 x 1340 mm	A100
108707	Tuning-Scheibe mittel	Tuning disc medium	Disque de tuning medium	Disco tuning medio	350 x 60 x 203 mm	
108708	Tuning-Scheibe mittel	Tuning disc medium	Disque de tuning medium	Disco tuning medio	350 x 70 x 203 mm / 232 x 10 mm	
108709	Tuning-Scheibe mittel	Tuning disc medium	Disque de tuning medium	Disco tuning medio	350 x 80 x 203 mm / 232 x 10 mm	
104929	Filterstrumpf (Box)	Nylon filter (box)	Filtre nylon (boîte)	Base filtrante in nylon (box)	40 m	
101889	Filterrolle	Filter roll	Rouleau de filtre	Rullo filtrante	540 mm x 100 m	T 12
106385	Schleifemulsion	Sanding emulsion	Emulsion de ponçage	Emulsione per rettifiche	25 lt	V3

## CHALLENGE / CHALLENGE MAX

109313	Schleifring	Grinding ring	Anneau de ponçage	Anello di rettifica	350 x 320 x 152 mm	A-36/KK10P
109464	Schleifring blau	Grinding ring blue	Anneau de ponçage bleu	Anello di rettifica blu	350 x 340 x 152 mm	A-36/KK10P
107538	Abrichtwerkzeug Stein	Dressing tool stone	Outil de dressage meule	Utensile di rettifica pietra		K 320 LF
107599	Abrichtsystem Plexi ohne Grundplatte	Dressing system plexi without base plate	Dresseur système en plexi sans plaque de base	Sistema di rettifica plexi senza base	320 mm	
101830	Schleifband	Sanding belt	Bande abrasive	Nastro abrasivo	30 x 910 mm	K 80
101831	Schleifband	Sanding belt	Bande abrasive	Nastro abrasivo	30 x 910 mm	K 100
105867	Tuning-Scheibe mittel	Tuning disc medium	Disque de tuning medium	Disco tuning medio	200 x 46 x 80 mm	
107682	Abrichtwerkzeug HTT	Dressing tool HTT	Outil de dressage HTT	Utensile di rettifica HTT		PW-V1555 LF
101889	Filterrolle	Filter roll	Rouleau de filtre	Rullo filtrante	540 mm x 100 m	T 12
104929	Filterstrumpf	Nylon filter (box)	Filtre nylon (boîte)	Base filtrante in nylon	40 m	
106385	Schleifemulsion	Sanding emulsion	Emulsion de ponçage	Emulsione per rettifiche	25 lt	V3

## SNOW CRUISER

109313	Schleifring	Grinding ring	Anneau de ponçage	Anello di rettifica	350 x 320 x 152 mm	A-36/KK10P
109464	Schleifring blau	Grinding ring blue	Anneau de ponçage bleu	Anello di rettifica blu	350 x 340 x 152 mm	A-36/KK10P
107538	Abrichtwerkzeug Stein	Dressing tool stone	Outil de dressage meule	Utensile di rettifica pietra		K 320 LF
107599	Abrichtsystem Plexi ohne Grundplatte	Dressing system plexi without base plate	Dresseur système en plexi sans plaque de base	Sistema di rettifica plexi senza base	320 mm	
101833	Schleifband	Sanding belt	Bande abrasive	Nastro abrasivo	30 x 1340 mm	K 80
101834	Schleifband	Sanding belt	Bande abrasive	Nastro abrasivo	30 x 1340 mm	K 100
101835	Schleifband	Sanding belt	Bande abrasive	Nastro abrasivo	30 x 1340 mm	K 120
105594	Tuning-Scheibe mittel	Tuning disc medium	Disque de tuning medium	Disco tuning medio	230 x 50 x 152 mm	
106402	Abrichtrolle Radial	Dressing rolls	Poulies de dressage	Rullo di rettifica radiale		
107682	Abrichtwerkzeug HTT	Dressing tool HTT	Outil de dressage HTT	Utensile di rettifica HTT		PW-V1555 LF
101889	Filterrolle	Filter roll	Rouleau de filtre	Rullo filtrante	540 mm x 100 m	T 12
104929	Filterstrumpf (Box)	Nylon filter (box)	Filtre nylon (boîte)	Base filtrante in nylon	40 m	
106385	Schleifemulsion	Sanding emulsion	Emulsion de ponçage	Emulsione per rettifiche	25 lt	V3

## MAS 2000 PS, TWISTER 8, SNOW STAR

109313	Schleifring	Grinding ring	Anneau de ponçage	Anello di rettifica	350 x 320 x 152 mm	A-36/KK10P
109464	Schleifring blau	Grinding ring blue	Anneau de ponçage bleu	Anello di rettifica blu	350 x 340 x 152 mm	A-36/KK10P
107538	Abrichtwerkzeug	Dressing tool	Outil de dressage	Utensile di rettifica pietra		K 320 LF
107599	Abrichtsystem Plexi ohne Grundplatte	Dressing system plexi without base plate	Dresseur système en plexi sans plaque de base	Sistema di rettifica plexi senza base	320 mm	
101889	Filterrolle	Filter roll	Rouleau de filtre	Rullo filtrante	540 mm x 100 m	T 12
106515	Filterrolle	Filter roll	Rouleau de filtre	Rullo filtrante	750 mm x 100 m	
104929	Filterstrumpf	Nylon filter (box)	Filtre nylon (boîte)	Base filtrante in nylon (box)	40 m	
106385	Schleifemulsion	Sanding emulsion	Emulsion de ponçage	Emulsione per rettifiche	25 lt	V3

# VERBRAUCHSMATERIAL

MACHINE CONSUMABLES / MATÉRIAUX DE CONSOMMATION / MATERIALE DI CONSUMO

## MODULAR 4



## CARVE POWER (MAS 2000 GSW HTT)



## MONTY AS-0

## CARVER (GHTT 2000)

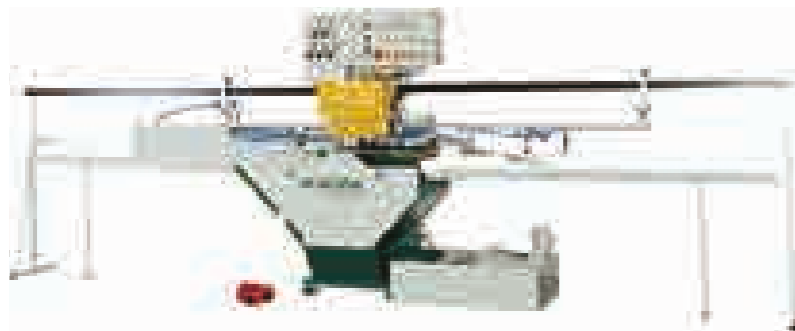

## CRYSTAL EDGE

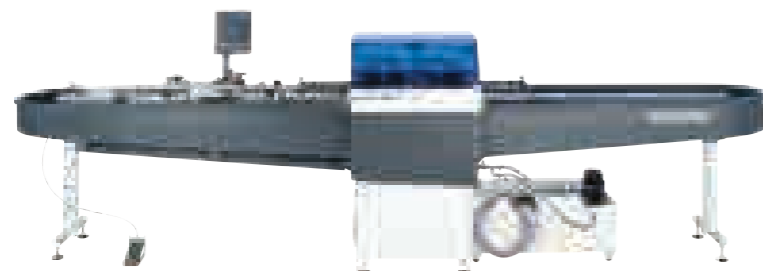

## MODULAR 4 (MAS 2000 GGB HTT)

101912	Schleifring	Grinding ring	Anneau de ponçage	Anello di rettifica	350 x 125 x 203 mm	E 30/2
105231	Schleifring	Grinding ring	Anneau de ponçage	Anello di rettifica	350 x 135 x 203 mm	A 36/LB
107681	Abrichtwerkzeug Stein	Dressing tool stone	Outil de dressage meule	Utensile di rettifica pietra		K 125 LF
102016	Abrichtholz	Wooden block	Bois de dressage	Legno di rettifica	125 mm	
102017	Abrichtholz	Wooden block	Bois de dressage	Legno di rettifica	135 mm	
105594	Tuning-Scheibe mittel	Tuning disc medium	Disque de tuning medium	Disco tuning medio	230 x 50 x 152 mm	
107682	Abrichtwerkzeug HTT	Dressing tool HTT	Outil de dressage HTT	Utensile di rettifica HTT		PW-V1555 LF
106402	Abrichtrolle Radial	Dressing rolls	Poulies de dressage	Rullo di rettifica radiale		
101830	Schleifband	Sanding belt	Bande abrasive	Nastro abrasivo	30 x 910 mm	K 80
101831	Schleifband	Sanding belt	Bande abrasive	Nastro abrasivo	30 x 910 mm	K 100
101889	Filterrolle	Filter roll	Rouleau de filtre	Rullo filtrante	540 mm x 100 m	T 12
104929	Filterstrumpf (Box)	Nylon filter (box)	Filtre nylon (boîte)	Base filtrante in nylon (box)	40 m	
106385	Schleifemulsion	Sanding emulsion	Emulsion de ponçage	Emulsione per rettifiche	25 lt	V3

## CARVE POWER (MAS 2000 GSW HTT)

105594	Tuning-Scheibe mittel	Tuning disc medium	Disque de tuning medium	Disco tuning medio	230 x 50 x 152 mm	
107682	Abrichtwerkzeug HTT	Dressing tool HTT	Outil de dressage HTT	Utensile di rettifica HTT		PW-V1555 LF
101830	Schleifband	Sanding belt	Bande abrasive	Nastro abrasivo	30 x 910 mm	K 80
101831	Schleifband	Sanding belt	Bande abrasive	Nastro abrasivo	30 x 910 mm	K 100
101809	Wachsband	Waxing belt	Bande de fartage	Nastro cerato	150 x 1500 mm	
106088	Wachs gelb	Wax yellow	Fart jaune	Sciolina gialla	1 kg (4 x 250 g)	
106089	Wachs grün	Wax green	Fart vert	Sciolina verde	1 kg (4 x 250 g)	
106090	Wachs blau	Wax blue	Fart bleu	Sciolina blu	1 kg (4 x 250 g)	
104929	Filterstrumpf (Box)	Nylon filter (box)	Filtre nylon (boîte)	Base filtrante in nylon (box)	40 m	
106385	Schleifemulsion	Sanding emulsion	Emulsion de ponçage	Emulsione per rettifiche	25 lt	V3

## MONTY AS-0

101912	Schleifring	Grinding ring	Anneau de ponçage	Anello di rettifica	350 x 125 x 203 mm	E30/2
101904	Schleifstein	Grinding stone	Meule de ponçage	Pietra di rettifica	350 x 115 x 50 mm	E30/2 A
107681	Abrichtwerkzeug Stein	Dressing tool stone	Outil de dressage meule	Utensile di rettifica pietra		K 125 LF
101889	Filterrolle	Filter roll	Rouleau de filtre	Rullo filtrante	540 mm x 100 m	T 12
104929	Filterstrumpf (Box)	Nylon filter (box)	Filtre nylon (boîte)	Base filtrante in nylon (box)	40 m	
106384	Schleifemulsion	Sanding emulsion	Emulsion de ponçage	Emulsione per rettifiche	10 lt	V3

## CARVER (GHTT 2000)

101830	Schleifband	Sanding belt	Bande abrasive	Nastro abrasivo	30 x 910 mm	K 80
101831	Schleifband	Sanding belt	Bande abrasive	Nastro abrasivo	30 x 910 mm	K 100
105594	Tuning-Scheibe mittel	Tuning disc medium	Disque de tuning medium	Disco tuning medio	230 x 50 x 152 mm	
106402	Abrichtrolle Radial	Dressing roll	Poulie de dressage	Rullo di rettifica radiale		
104929	Filterstrumpf (Box)	Nylon filter (box)	Filtre nylon (boîte)	Base filtrante in nylon (box)	40 m	
106384	Schleifemulsion	Sanding emulsion	Emulsion de ponçage	Emulsione per rettifiche	10 lt	V3

## CRYSTAL EDGE

101830	Schleifband	Sanding belt	Bande abrasive	Nastro abrasivo	30 x 910 mm	K 80
101831	Schleifband	Sanding belt	Bande abrasive	Nastro abrasivo	30 x 910 mm	K 100
105867	Tuning-Scheibe mittel	Tuning disc medium	Disque de tuning medium	Disco tuning medio	200 x 46 x 80 mm	
107682	Abrichtwerkzeug HTT	Dressing tool HTT	Outil de dressage HTT	Utensile di rettifica HTT		PW-V1555 LF
104929	Filterstrumpf	Nylon filter (box)	Filtre nylon (boîte)	Base filtrante in nylon (box)	40 m	
106384	Schleifemulsion	Sanding emulsion	Emulsion de ponçage	Emulsione per rettifiche	10 lt	V3

# VERBRAUCHSMATERIAL

MACHINE CONSUMABLES / MATÉRIAUX DE CONSOMMATION / MATERIALE DI CONSUMO

HTT 2000



TUNING MASTER



HTT 3D - FINISH



M 2000 COMBI



M 2000

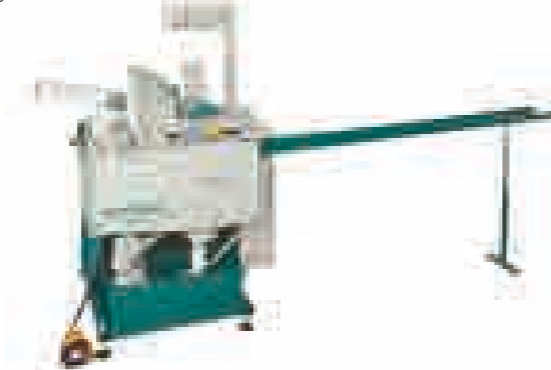

M 2000 CCS



M 2000 E



CRYSTAL INLINE



CRYSTAL SB COMBI



CRYSTAL S



## HTT 2000, TUNING MASTER

105594	Tuning-Scheibe mittel	Tuning disc medium	Disque de tuning medium	Disco tuning medio	230 x 50 x 152 mm	
107682	Abrihtwerkzeug	Dressing tool	Outil de dressage	Utensile di rettifica		PW-V1555 LF
106402	Abrihtrolle Radial	Dressing rolls	Poulies de dressage	Rullo di piallatura radiale		
104929	Filterstrumpf (Box)	Nylon filter (box)	Filtre nylon (boîte)	Base filtrante in nylon (box)	40 m	
106384	Schleifemulsion	Sanding emulsion	Emulsion de ponçage	Emulsione per rettifiche	10 lt	V3

## HTT 3D – FINISH

101873	Abrihtknopf	Dressing tool	Outil de dressage	Bottone per rettifica	145 x 199 x 18 mm	
108251	Polierscheibe	Polishing disc	Disque polissage	Disco di lucidatura	200 x 20 x 140 mm	
108252	Polierscheibe	Polishing disc	Disque polissage	Disco di lucidatura	240 x 20 x 180 mm	
101827	Schleifband	Sanding belt	Bande abrasive	Nastro abrasivo	30 x 623 mm	K 80
101828	Schleifband	Sanding belt	Bande abrasive	Nastro abrasivo	30 x 623 mm	K 100
104929	Filterstrumpf (Box)	Nylon filter (box)	Filtre nylon (boîte)	Base filtrante in nylon (box)	40 m	
106384	Schleifemulsion	Sanding emulsion	Emulsion de ponçage	Emulsione per rettifiche	10 lt	V3

## M 2000 COMBI, M 2000

101912	Schleifring	Grinding ring	Anneau de ponçage	Anello di rettifica	350 x 125 x 203 mm	E 30/2
107681	Abrihtwerkzeug	Dressing tool	Outil de dressage	Utensile di rettifica		K 125 LF
101840	Schleifband	Sanding belt	Bande abrasive	Nastro abrasivo	150 x 1500 mm	K 80
101809	Wachsband	Waxing belt	Bande de fartage	Nastro per sciolinatura	150 x 1500 mm	
106219	Kantentuningband	Edge tuning belt	Inclinaison des carres	Nastro tuning per lamine	150 x 1500 mm	K 80
104929	Filterstrumpf (Box)	Nylon filter (box)	Filtre nylon (boîte)	Base filtrante in nylon (box)	40 m	
106384	Schleifemulsion	Emulsion de ponçage	Sanding emulsion	Emulsione per rettifiche	10 lt	V3

Weiteres Zubehör finden Sie in den entsprechenden Rubriken / More accessories on the precedent pages  
Autres accessoires vous trouverez dans les pages précédentes / Altri accessori sono riportati nelle pagine precedenti

## MC 2000 CCS, MC 2000 E

101908	Schleifstein	Grinding stone	Anneau de ponçage	Pietra di rettifica	300 x 125 x 50 mm	A E 30/2
107681	Abrihtwerkzeug	Dressing tool	Outil de dressage	Utensile di rettifica		K 125 LF
104929	Filterstrumpf (Box)	Nylon filter (box)	Filtre nylon (boîte)	Base filtrante in nylon (box)	40 m	
106384	Schleifemulsion	Sanding emulsion	Emulsion de ponçage	Emulsione per rettifiche	10 lt	V3

Weiteres Zubehör finden Sie in den entsprechenden Rubriken / More accessories on the precedent pages  
Autres accessoires vous trouverez dans les pages précédentes / Altri accessori sono riportati nelle pagine precedenti

## CRYSTAL INLINE , CRYSTAL S, CRYSTAL SB COMBI

109463	Schleifring	Grinding ring	Anneau de ponçage	Anello di rettifica	300 x 340 x 125 mm	A 36/KK 10P
107538	Abrihtwerkzeug	Dressing tool	Outil de dressage	Utensile di rettifica		K 320 LF
101856	Schleifband	Sanding belt	Bande abrasive	Nastro abrasivo	345 x 1615 mm	K 80
101857	Schleifband	Sanding belt	Bande abrasive	Nastro abrasivo	345 x 1615 mm	K 100
101858	Schleifband	Sanding belt	Bande abrasive	Nastro abrasivo	345 x 1615 mm	K 120
101814	Wachsband	Waxing belt	Bande de fartage	Nastro per sciolinatura	345 x 1615 mm	MSG
105229	Wachsband gelb	Waxing belt yellow	Brande de fartage jaune	Nastro per sciolinatura giallo	345 x 1615 mm	
105743	Trizact braun	Trizact brown	Trizact brun	Trizact marrone	345 x 1615 mm	
107192	Trizact blau	Trizact blue	Trizact bleu	Trizact blu	345 x 1615 mm	
106220	Kantentuningband	Edge tuning belt	Inclinaison des carres	Disco tuning per lamine	345 x 1615 mm	K 80
104929	Filterstrumpf	Nylon filter (box)	Filtre nylon (boîte)	Base filtrante in nylon (box)	40 m	
106384	Schleifemulsion	Sanding emulsion	Emulsion de ponçage	Emulsione per rettifiche	10 lt	V3

Weiteres Zubehör finden Sie in den entsprechenden Rubriken / More accessories on the precedent pages  
Autres accessoires vous trouverez dans les pages précédentes / Altri accessori sono riportati nelle pagine precedenti

# VERBRAUCHSMATERIAL

MACHINE CONSUMABLES / MATÉRIAUX DE CONSOMMATION / MATERIALE DI CONSUMO

M 2000 CSB



M 2000 SBS PRO



M 2000 CBS PRO



SNOWRIDER



SNOWBOARD LC



MONTY BELT



SNOWBOARD UNIVERSAL 2



GMU 2000



## M 2000 CSB, M 2000 SBS PRO, M 2000 CBS PRO

109313	Schleifring	Anneau de ponçage	Grinding ring	Anello di rettifica	350 x 320 x 152 mm	A-36/KK10P
107538	Abrichtwerkzeug	Outil de dressage	Dressing tool	Utensile di rettifica		K 320 LF
104929	Filterstrumpf	Filtre nylon (boîte)	Nylon filter (box)	Base filtrante in nylon (box)	40 m	
106384	Schleifemulsion	Emulsion de ponçage	Sanding emulsion	Emulsione per rettifiche	10 lt	V3

## SNOWRIDER

101844	Schleifband	Sanding belt	Bande abrasive	Nastro abrasivo	355 x 2050 mm	K 80
101845	Schleifband	Sanding belt	Bande abrasive	Nastro abrasivo	355 x 2050 mm	K 100
101846	Schleifband	Sanding belt	Bande abrasive	Nastro abrasivo	355 x 2050 mm	K 120
105744	Trizact braun	Trizact brown	Trizact brun	Trizact marrone	355 x 2050 mm	
101815	Wachsband	Waxing belt	Bande de fartage	Nastro per sciolinatura giallo	355 x 2050 mm	MSG
105230	Wachsband gelb	Waxing belt yellow	Bande de fartage jaune	Nastro per sciolinatura giallo	355 x 2050 mm	
104929	Filterstrumpf	Nylon filter (box)	Filtre nylon (boîte)	Base filtrante in nylon (box)	40 m	
106384	Schleifemulsion	Sanding emulsion	Emulsion de ponçage	Emulsione per rettifiche	10 lt	V3

Weiteres Zubehör finden Sie in den entsprechenden Rubriken / More accessories on the precedent pages

Autres accessoires vous trouverez dans les pages précédentes / Altri accessori sono riportati nelle pagine precedenti

## SNOWBOARD LC, MONTY BELT

101856	Schleifband	Sanding belt	Bande abrasive	Nastro abrasivo	345 x 1615 mm	K 80
101857	Schleifband	Sanding belt	Bande abrasive	Nastro abrasivo	345 x 1615 mm	K 100
101858	Schleifband	Sanding belt	Bande abrasive	Nastro abrasivo	345 x 1615 mm	K 120
101825	Schleifband	Sanding belt	Bande abrasive	Nastro abrasivo	20 x 1100 mm	K80
101826	Schleifband	Sanding belt	Bande abrasive	Nastro abrasivo	20 x 1100 mm	K100
101814	Wachsband	Waxing belt	Bande de fartage	Nastro per sciolinatura	345 x 1615 mm	MSG
105229	Wachsband gelb	Waxing belt yellow	Bande de fartage jaune	Nastro per sciolinatura giallo	345 x 1615 mm	
105743	Trizact braun	Trizact brown	Trizact brun	Trizact marrone	345 x 1615 mm	
107192	Trizact blau	Trizact blue	Trizact bleu	Trizact blu	345 x 1615 mm	
106220	Kantentuningband	Edge tuning belt	Inclinaison des carres	Nastro tuning per lamine	345 x 1615 mm	
104929	Filterstrumpf	Nylon filter (box)	Filtre nylon (boîte)	Base filtrante in nylon (box)	40 m	
106384	Schleifemulsion	Sanding emulsion	Emulsion de ponçage	Emulsione per rettifiche	10 lt	V3

Weiteres Zubehör finden Sie in den entsprechenden Rubriken / More accessories on the precedent pages

Autres accessoires vous trouverez dans les pages précédentes / Altri accessori sono riportati nelle pagine precedenti

## SNOWBOARD UNIVERSAL 2

101848	Schleifband	Sanding belt	Bande abrasive	Nastro abrasivo	400 x 1012 mm	K 80
101849	Schleifband	Sanding belt	Bande abrasive	Nastro abrasivo	400 x 1012 mm	K 100
101812	Wachsband	Waxing belt	Bande de fartage	Nastro per sciolinatura	400 x 1012 mm	MSG
104929	Filterstrumpf	Nylon filter (box)	Filtre nylon (boîte)	Base filtrante in nylon (box)	40 m	
106384	Schleifemulsion	Sanding emulsion	Emulsion de ponçage	Emulsione per rettifiche	10 lt	V3

## GMU 2000

101840	Schleifband	Sanding belt	Bande abrasive	Nastro abrasivo	150 x 1500 mm	K 80
101841	Schleifband	Sanding belt	Bande abrasive	Nastro abrasivo	150 x 1500 mm	K 100
107191	Trizact blau	Trizact blue	Trizact bleu	Trizact blu	150 x 1500 mm	
101809	Wachsband	Waxing belt	Bande de fartage	Nastro per sciolinatura	150 x 1500 mm	extra fine
101810	Wachsband	Waxing belt	Bande de fartage	Nastro per sciolinatura	150 x 1500 mm	MSG
105228	Wachsband gelb	Waxing belt yellow	Bande de fartage jaune	Nastro per sciolinatura giallo	150 x 1500 mm	
106219	Kantentuningband	Edge tuning belt	Inclinaison des carres	Nastro tuning per lamine	150 x 1500 mm	K 80
104929	Filterstrumpf (Box)	Nylon filter (box)	Filtre nylon (boîte)	Base filtrante in nylon (box)	40 m	
106384	Schleifemulsion	Sanding emulsion	Emulsion de ponçage	Emulsione per rettifiche	10 lt	V3

# VERBRAUCHSMATERIAL

MACHINE CONSUMABLES / MATÉRIAUX DE CONSOMMATION / MATERIALE DI CONSUMO

DSG 2000



MCS 2000



KSM MONTY  
(Typ 600 + Typ 650)



COMPACT 2000



SK-COMPACT



MSG 2000



RACE EDGE

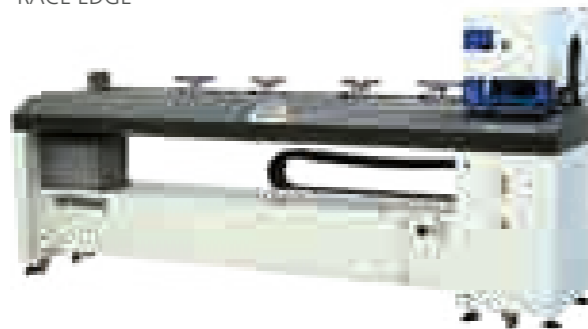

MONTY EDGER



COMPACT EDGE ST



## DSG 2000

101837	Schleifband	Sanding belt	Bande abrasive	Nastro abrasivo	30 x 1500 mm	K 80
101838	Schleifband	Sanding belt	Bande abrasive	Nastro abrasivo	30 x 1500 mm	K 100
104929	Filterstrumpf (Box)	Nylon filter (box)	Filtre nylon (boîte)	Base filtrante in nylon (box)	40 m	
106384	Schleifemulsion	Sanding emulsion	Emulsion de ponçage	Emulsione per rettifiche	10 lt	V3

## MCS 2000, KSM MONTY (TYP 600 + TYP 650)

101833	Schleifband	Sanding belt	Bande abrasive	Nastro abrasivo	30 x 1340 mm	K 80
101834	Schleifband	Sanding belt	Bande abrasive	Nastro abrasivo	30 x 1340 mm	K 100
101835	Schleifband	Sanding belt	Bande abrasive	Nastro abrasivo	30 x 1340 mm	K 120
104929	Filterstrumpf (Box)	Nylon filter (box)	Filtre nylon (boîte)	Base filtrante in nylon (box)	40 m	
106384	Schleifemulsion	Sanding emulsion	Emulsion de ponçage	Emulsione per rettifiche	10 lt	V3

## COMPACT 2000

101825	Schleifband	Sanding belt	Bande abrasive	Nastro abrasivo	20 x 1100 mm	K 80
101826	Schleifband	Sanding belt	Bande abrasive	Nastro abrasivo	20 x 1100 mm	K 100
104929	Filterstrumpf (Box)	Nylon filter (box)	Filtre nylon (boîte)	Base filtrante in nylon (box)	40 m	
106384	Schleifemulsion	Sanding emulsion	Emulsion de ponçage	Emulsione per rettifiche	10 lt	V3

## COMPACT SEITENKANTENAGGREGAT

Side Edge Aggregate / Agrégat pour l'affûtage des carres latérales / Aggregato per lamina

101827	Schleifband	Sanding belt	Bande abrasive	Nastro abrasivo	30 x 623 mm	K 80
101828	Schleifband	Sanding belt	Bande abrasive	Nastro abrasivo	30 x 623 mm	K 100

## MSG 2000

101830	Schleifband	Sanding belt	Bande abrasive	Nastro abrasivo	30 x 910 mm	K 80
101831	Schleifband	Sanding belt	Bande abrasive	Nastro abrasivo	30 x 910 mm	K 100
104929	Filterstrumpf (Box)	Nylon filter (box)	Filtre nylon (boîte)	Base filtrante in nylon (box)	40 m	
106384	Schleifemulsion	Sanding emulsion	Emulsion de ponçage	Emulsione per rettifiche	5 lt	V3

## MONTY EDGER, RACE EDGE

109311	Anschlagwinkel	Edge angle	Pince angulaire	Squadra di arresto	86 °	
109023	Topfscheibe	Disc	Disque	Disco		K 80
107533	Topfscheibe	Disc	Disque	Disco		K 120
107534	Topfscheibe	Disc	Disque	Disco		K 240
107535	Topfscheibe	Disc	Disque	Disco		K 320
107536	Topfscheibe	Disc	Disque	Disco		K 500
108451	Schleifemulsion	Sanding emulsion	Emulsion de ponçage	Emulsione per rettifiche	70 ml	V3
106381	Schleifemulsion	Sanding emulsion	Emulsion de ponçage	Emulsione per rettifiche	1 lt	V3
105088	Sauggummi Silikon, 2-Lippen, schwarz	Silicone seals, double-lips, black	Joints d'aspiration en silicone, 2 lèvres, noir	Ventosa in gomma siliconica, doppia, nera		RACE EDGE
108954	Innenplatte gross	Large inner plate	Grande plaque intérieure	Pannello interno grande		RACE EDGE
105312	Sauggummi Silikon, 2-Lippen, rot, für Kinderski	Silicone seals, double-lips, red, for children's skis	Joints d'aspiration en silicone, 2 lèvres, rouge, ski enfants	Ventosa in gomma siliconica, doppia, rossa, per sci per bambini		RACE EDGE
108955	Innenplatte 14 mm, für Kinderski	14 mm inner plate, for children's skis	Plaque intérieure 14 mm, ski enfants	Pannello interno 14 mm, per sci per bambini		RACE EDGE

## COMPACT EDGE S / ST

107533	Topfscheibe	Disc	Disque	Disco		K 120
108986	Tuning-Scheibe Mittel	disc medium	Disque tuning médium	Disco tuning medio	90x25x12 mm/30x15 mm	
109382	Diamantscheibe ST	Diamond disc ST	Disque diamantée ST	Disco diamantato ST		
106381	Schleifemulsion	Sanding emulsion	Emulsion de ponçage	Emulsione per rettifiche	1 lt	V3
104929	Filterstrumpf (Box)	Nylon filter (box)	Filtre nylon (boîte)	Base filtrante in nylon (box)	40 m	

# VERBRAUCHSMATERIAL

MACHINE CONSUMABLES / MATÉRIAUX DE CONSOMMATION / MATERIALE DI CONSUMO

P-TEX MASTER



P-TEX SPEEDMASTER



## P-TEX MASTER, P-TEX SPEEDMASTER

101961	P-TEX Schweissdraht transparent	P-TEX wire clear	Fil à souder P-TEX transparent	Filo di saldatura P-TEX trasparente	3 mm x 260 m
101962	P-TEX Schweissdraht schwarz	P-TEX wire black	Fil à souder P-TEX noir	Filo di saldatura P-TEX nero	3 mm x 260 m

## MRS 2000, GSA 2000

101965	P-TEX Schweissdraht transparent	P-TEX wire clear	Fil à souder P-TEX transparent	Filo di saldatura P-TEX trasparente	5 mm x 200 m
101966	P-TEX Schweissdraht schwarz	P-TEX wire black	Fil à souder P-TEX noir	Filo di saldatura P-TEX nero	5 mm x 200 m

## MONTY EXTRUDER

101963	P-TEX Schweissdraht transparent	P-TEX wire clear	Fil à souder P-TEX transparent	Filo di saldatura P-TEX trasparente	3 mm x 70 m
101964	P-TEX Schweissdraht schwarz	P-TEX wire black	Fil à souder P-TEX noir	Filo di saldatura P-TEX nero	3 mm x 70 m
101965	P-TEX Schweissdraht transparent	P-TEX wire clear	Fil à souder P-TEX transparent	Filo di saldatura P-TEX trasparente	5 mm x 200 m
101966	P-TEX Schweissdraht schwarz	P-TEX wire black	Fil à souder P-TEX noir	Filo di saldatura P-TEX nero	5 mm x 200 m

MRS 2000

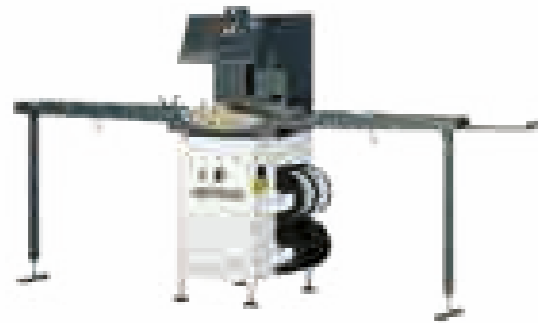

GSA 2000



MONTY EXTRUDER





**JETBOND**

**METALLPAPIER**

**Metallic paper / Papier métallisé / Carta metallica**

silber / silver / argent / argento

Wälzholz-Huber DMG / Jetbond 1990 – 2004

MP-989006 Rolle / roll / rouleau / rotolo



**THERMOPAPIER**

**Thermopaper / Papier thermo / Carta termica**

weiss / white / blanc / bianca

Jetbond 2004 –

MP-989007 Rolle / roll / rouleau / rotolo



**PRÜFSOHLÉ / VORSAISONPRÜFUNG**

**Norme sole / preseason testing**

**Semelle norme / contrôle pré-saison**

**Suola a norma / controllo prestagionale**

MP-214025 ISO Norm Jetbond E / T

MP-214038 ISO Norm Jetbond S / M

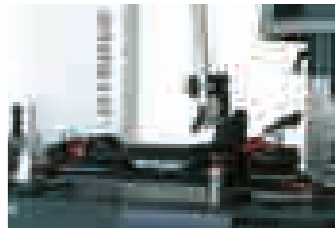

**AUSLÖSEBAND**

**Release band / Bande de déclenchement / Nastro di distacco**

MP-214010 Jetbond T, K, E 20 cm kurz / short / court / corto

MP-214039 Jetbond S 25 cm lang / long / longue / lungo



**BARCODES ROLLEN**

**Barcodes einseitig mit Logo / Barcodes one-sided with logo**

**Codes-barres sur une face avec logo / Codici a barre su un lato con logo**

110351 Rolle / roll / rouleau / ruolo

Mit 500 Aufkleber / of 500 stickers

Rouleau de 500 étiquettes / a 500 adesivi



# MONTANA STRUKTUREN

Der legendäre MONTANA Steinschliff sorgt für exakt geschnittene Strukturen. Die am häufigsten verwendeten Strukturen sind standardmäßig in der Software hinterlegt. Die MONTANA VARIO-Strukturen ermöglichen unterschiedliche Strukturbilder über die Breite des Sportgerätes.

The legendary stone grinding system allows precisely cut structures. The most commonly used structures are used as standard in the software. The MONTANA VARIO structure allows different structure pictures over the width of the ski or board.

Les légendaires pierres de ponçage MONTANA veille à une reproduction exacte et précise de la structure désirée. Les structures les plus fréquemment utilisées sont déjà programmées dans le software. Le système VARIO de MONTANA permet d'adapter des structures différentes sur toute la largeur de la semelle.

La leggendaria rettifica a pietra MONTANA permette di ottenere strutture precisamente rettificate. Le strutture più frequentemente utilizzate sono inserite come standard nel software. Le strutture MONTANA VARIO permettono di configurare le strutture nei modi più svariati, oltre la larghezza dell'attrezzo.

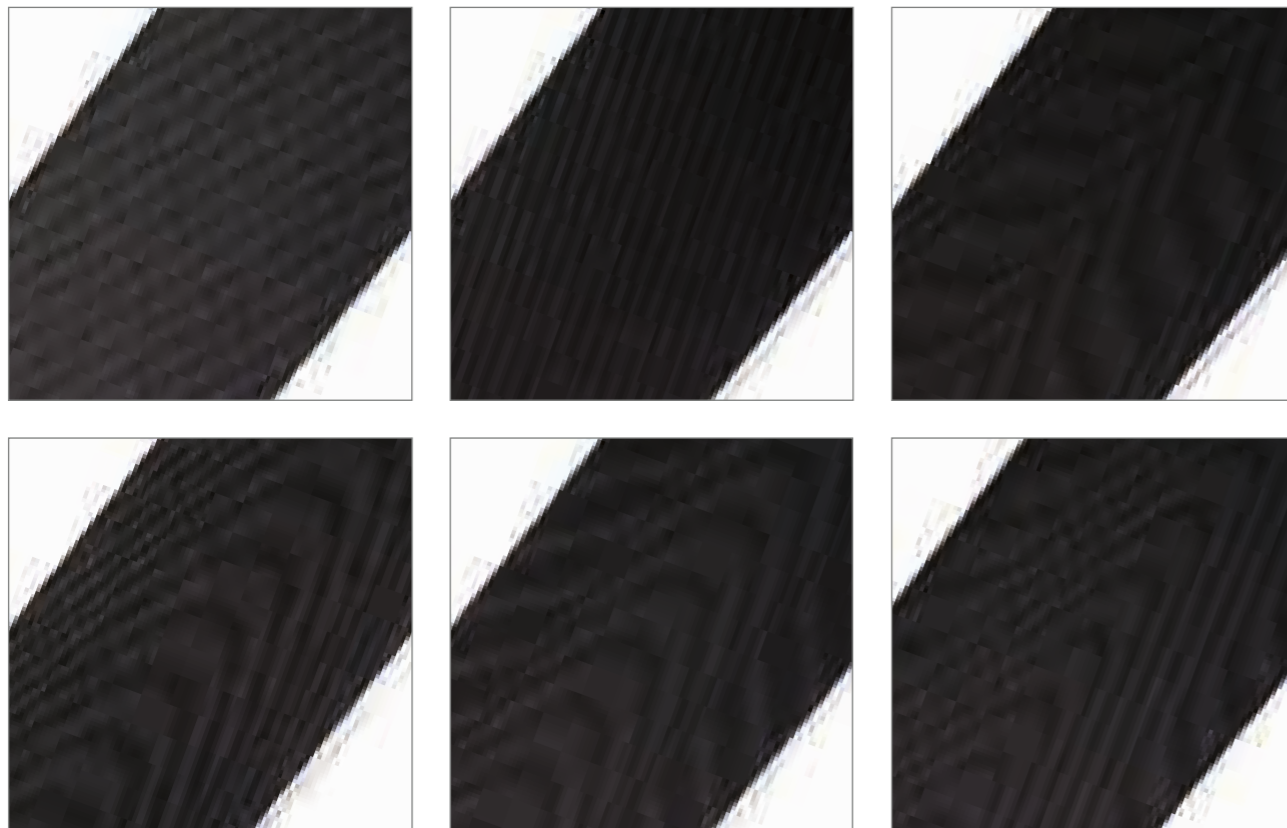

## Vorteile der PRO-Technologie

- Hochpräzise Kraftkurve für alle Skimodelle
- Durch NC-Technologie separat für jeden Stein individuell und fein regelbar
- Ski: Twin Tip, Rocker, Freeride und Boards, Schleifen von Schaufel bis Skiende möglich
- Genauere und bessere Schleifleistung über die ganze Skilänge
- Der Steinschliffprozess wird sehr harmonisch ausgeführt



## Advantages of the PRO technology

- High precision force curves for all ski models
- NC technology for separate, precise adjustment of each stone
- Ski: Twin tip, rocker, freeride skis, and snowboards, can grind from shovel to the tail
- More accurate and better grinding along the entire length of the ski
- The stone grinding process runs very harmonic

## Avantages de la technologie PRO

- Courbe de force ultra précise pour tous les modèles de ski
- Grâce à la technologie NC, réglable séparément pour chaque pierre, de façon individuelle et fine
- Ski: Twin tip, rocker, freeride et snowboards, possibilité d'affûtage de la spatule au talon
- Performance d'affûtage plus précise et améliorée sur toute la longueur du ski
- Le processus d'affûtage à la pierre est très harmonieux

## Vantaggi della tecnologia PRO

- Curva di forza altamente precisa per tutti i modelli di sci
- Regolabile separatamente per ogni pietra, finemente e in modo individuale, con la tecnologia NC
- Sci: Twin tip, rocker, freeride e tavole, possibile rettifica dalla spatola alla coda
- Rettifica migliore e più precisa per tutta la lunghezza dello sci
- Il processo di rettifica a pietra viene eseguito in modo molto armonico

## BLUE PEARL 2.0

HOCHLEISTUNGS-SERVICEROBOTER FÜR SKI | HIGH PERFORMANCE SKI SERVICE ROBOTUN ROBOT  
D'ENTRETIEN ULTRA PUISSANT POUR LES SKIS | ROBOT DI ASSISTENZA ALTAMENTE PERFORMANTE PER GLI SCI.

80/h  
GRIP<sup>tech</sup>

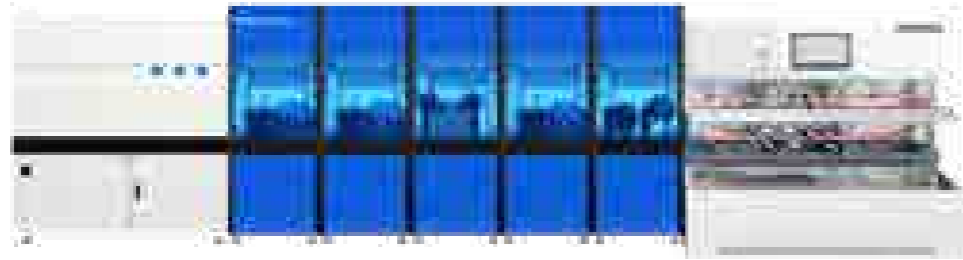

Vermassung ohne Wasserbecken

Die BLUE PEARL 2.0 ist unsere schnellste Full-Service-Anlage ohne an Qualität einzubüssen.

Massification without water tank

The BLUE PEARL 2.0 is our fastest full-service system without sacrificing quality.

La massification sans réservoir d'eau

La BLUE PEARL 2.0 est notre installation à service complet la plus rapide, sans perte de qualité.

Massificazione senza serbatoio

BLUE PEARL 2.0 è il nostro sistema a servizio completo più veloce, senza compromessi sulla qualità.

## CRYSTAL MAGIC

GENIALES ROBTER-SYSTEM FÜR SKI UND SNOWBOARD IM PREMIUM SEGMENT | INGENIOUS ROBOT SYSTEM FOR PREMIUM SKIS AND SNOWBOARDS | UN SYSTÈME DE ROBOT ASTUCIEUX POUR LES SKIS ET SNOWBOARDS HAUT DE GAMME | GENIALE SISTEMA DI ROBOT PER SCI E SNOWBOARD NEL SEGMENTO DELLA GAMMA PREMIUM.

45/h  
GRIP<sup>tech</sup>



Mit Beladung  
With loading system  
Avec chargeur  
Con caricatore

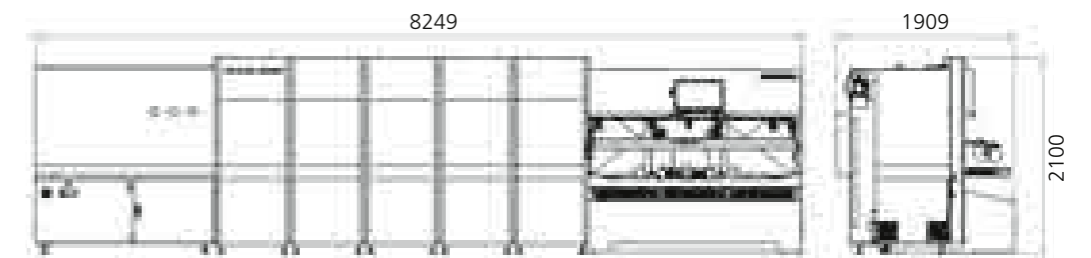

Hochleistungs Roboter mit zwei Steinen. Automatisches Steinschleifen für 1 Paar Ski oder 1 Snowboard mit PRO-Technologie.

High performance robot with two stones. Automatic stone grinding for 1 pair of skis or 1 snowboard with PRO technology.

Robot à haut rendement avec deux meules. Ponçage à pierre automatique pour 1 paire de skis ou 1 snowboard avec la technologie PRO.

Robot ad alta potenza con due pietre. Rettifica automatica per 1 paio di sci o 1 snowboard con tecnologia PRO.

## CRYSTAL ONYX

HOCHLEISTUNGS-SERVICEROBOTER FÜR SKI | HIGH PERFORMANCE SKI SERVICE ROBOTUN ROBOT D'ENTRETIEN  
ULTRA PUISSANT POUR LES SKIS | ROBOT DI ASSISTENZA ALTAMENTE PERFORMANTE PER GLI SCI.

50/h  
GRIP<sup>tech</sup>



Mit Beladung  
With loading system  
Avec chargeur  
Con caricatore

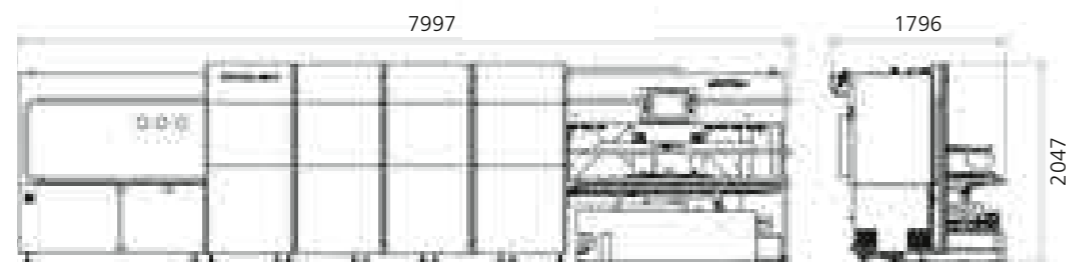

Vermassung ohne Wasserbecken

Höchster Durchsatz: 45 Paar Ski pro Stunde bei 4 Steinkontakten. Die Seitenkantenpräparation in GRIPtech Qualität.

Massification without water tank

Highest throughput: 45 pairs of skis per hour with 4 stone contacts. Side edge preparation in GRIPtech quality.

La massification sans réservoir d'eau

Rendement élevé: 45 paires de skis par heure pour 4 contacts de meule. La préparation des carres avec la qualité GRIPtech.

Massificazione senza serbatoio

Rendimento elevato: 45 paia di sci all'ora con 4 contatti pietra. La preparazione delle lamine con qualità GRIPtech.

## CRYSTAL MAGIC

GENIALES ROBTER-SYSTEM FÜR SKI UND SNOWBOARD IM PREMIUM SEGMENT | INGENIOUS ROBOT SYSTEM FOR PREMIUM SKIS AND SNOWBOARDS | UN SYSTÈME DE ROBOT ASTUCIEUX POUR LES SKIS ET SNOWBOARDS HAUT DE GAMME | GENIALE SISTEMA DI ROBOT PER SCI E SNOWBOARD NEL SEGMENTO DELLA GAMMA PREMIUM.

35/h  
GRIP<sup>tech</sup>

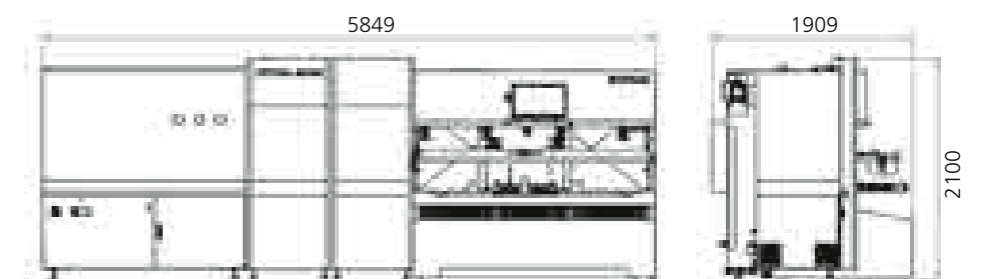

Allround-Roboter mit einem Stein. Automatisches Steinschleifen für 1 Paar Ski oder 1 Snowboard mit PRO Technologie.

Allround robot with one stone. Automatic stone grinding for 1 pair of skis or 1 snowboard with PRO technology.

Robot allround avec une meule. Ponçage à pierre automatique pour 1 paire de skis ou 1 snowboard avec la technologie PRO.

Robot allround con una pietra. Rettifica automatica per 1 paio di sci o 1 snowboard con tecnologia PRO.

# CRYSTAL MAGIC KONFIGURATIONEN

CONFIGURATIONS | CONFIGURATIONS | CONFIGURAZIONI

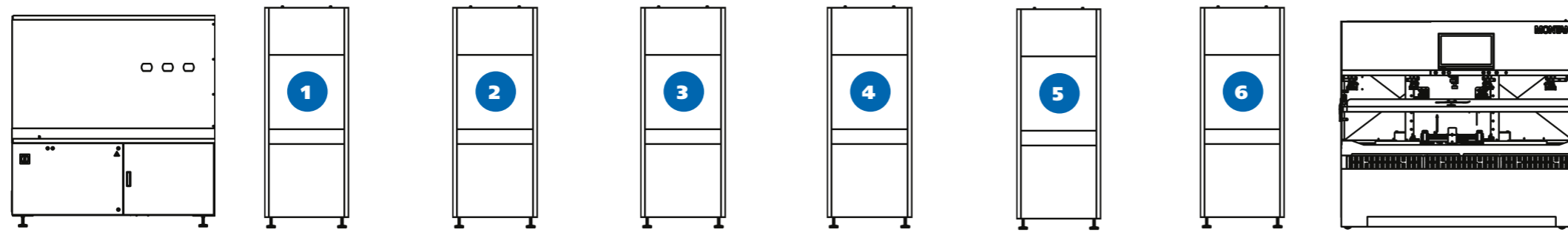

1. Stein Stone   Pierre   Pietra	2. Stein Stone   Pierre   Pietra	3. Stein Stone   Pierre   Pietra	1 x GRIPtech Einzel) Single   Simple   Semplice	Paarweise Skituning Tuning pairs of skis Tuning de ski par paire Tuning di un paio di sci	Wachsen Waxing Fartage Sciolinatura
			2 x GRIPtech (Doppelt) Dual   Double   Doppio		
			1 x GRIPtech (Einzel) 1 x RACEfinish		WinTheRace

MODUL	Stone (1) (2)					
1 MODUL	Stone (1) (2)					
2 MODULE	Stone (1) (2)					
3 MODULE	Stone (1)					
	Stone (1)					
	Stone (1) (2)					
	Stone (1) (2)					
	Stone (1)	Stone (1)				
4 MODULE	Stone (1)					
	Stone (1)					
	Stone (1)					
	Stone (1)					
	Stone (1)	Stone (1)				
	Stone (1)	Stone (1)				
	Stone (1)	Stone (1)				
	Stone (1)	Stone (1)				
	Stone (1)	Stone (1)				
	Stone (1)	Stone (1)				
5 MODULE	Stone (1)	Stone (1)				
	Stone (1)	Stone (1)				
	Stone (1)	Stone (1)				
	Stone (1)	Stone (1)				
	Stone (1)	Stone (1)				
	Stone (1)	Stone (1)	Stone (1)			
	Stone (1)	Stone (1)	Stone (1)			
6 MODULE	Stone (1)	Stone (1)	Stone (1)			
	Stone (1)	Stone (1)	Stone (1)			

Unser neues modulares System lässt sich in 6 Maschinengrößen zusammenfassen. Hierbei sind viele mögliche Varianten umsetzbar. Entscheidend sind Ihre Bedürfnisse!

Our new modular system can be summarised in 6 machine sizes. These offer lots of different versions. Your requirements are key!

Notre nouveau système modulaire peut s'assembler en 6 tailles de machine. De nombreuses variantes possibles peuvent être assemblées. Vos besoins sont décisifs!

Il nostro nuovo sistema modulare è riassumibile in macchinari di 6 dimensioni. A riguardo possono essere realizzate diverse varianti. L'elemento decisivo sono le tue esigenze!



## CRYSTAL ROCK

ALLROUND-ROBOTER FÜR MITTLERE UND KLEINE WERKSTÄTTEN | ALLROUND ROBOT FOR SMALL AND MEDIUM-SIZED SHOPS LE ROBOT POLYVALENT POUR LES ATELIERS DE MOYENNE ET PETITE TAILLE | ROBOT A TUTTO TONDO PER OFFICINE DI PICCOLE E MEDIE DIMENSIONI.



30 / h  
GRID<sup>tech</sup>



Allround-Roboter mit einem Stein.  
Automatisches Steinschleifen für  
1 Paar Ski oder 1 Snowboard mit  
Druckkurve.

Allround robot with one stone.  
Automatic stone grinding for 1  
pair of skis or 1 snowboard with  
pressure curve.

Robot allround avec une meule.  
Ponçage à pierre automatique pour  
1 paire de skis ou 1 snowboard  
avec courbe de pression.

Robot allround con una pietra. Rettifica  
automatica per 1 paio di sci o 1 snow-  
board con curva di pressione.

## CRYSTAL ROCK MAX W

ALLROUND-ROBOTER FÜR MITTLERE UND KLEINE WERKSTÄTTEN | ALLROUND ROBOT FOR SMALL AND MEDIUM-SIZED SHOPS LE ROBOT POLYVALENT POUR LES ATELIERS DE MOYENNE ET PETITE TAILLE | ROBOT A TUTTO TONDO PER OFFICINE DI PICCOLE E MEDIE DIMENSIONI.



35 / h  
GRID<sup>tech</sup>

Mit Beladung / Wachs-  
und Polieraggregat  
  
With loading system  
Waxing and polishing unit  
  
Avec chargeur / Unité de  
fartage et polissage  
  
Con caricatore / Gruppo  
sciolinatura e lucidatura



**MONTANA**<sup>®</sup>  
CRYSTAL GLIDE FINISH

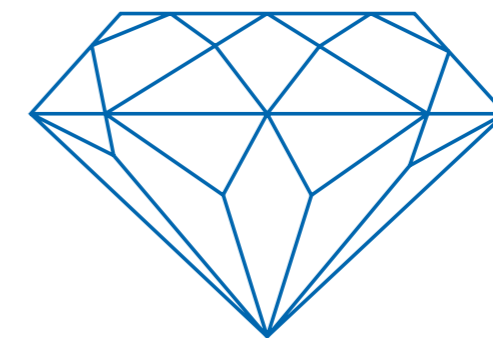

## CRYSTAL ROCK MAX

ALLROUND-ROBOTER FÜR MITTLERE UND KLEINE WERKSTÄTTEN | ALLROUND ROBOT FOR SMALL AND MEDIUM-SIZED SHOPS LE ROBOT POLYVALENT POUR LES ATELIERS DE MOYENNE ET PETITE TAILLE | ROBOT A TUTTO TONDO PER OFFICINE DI PICCOLE E MEDIE DIMENSIONI.



35 / h  
GRID<sup>tech</sup>

Mit Beladung  
With loading system  
Avec chargeur  
Con caricatore

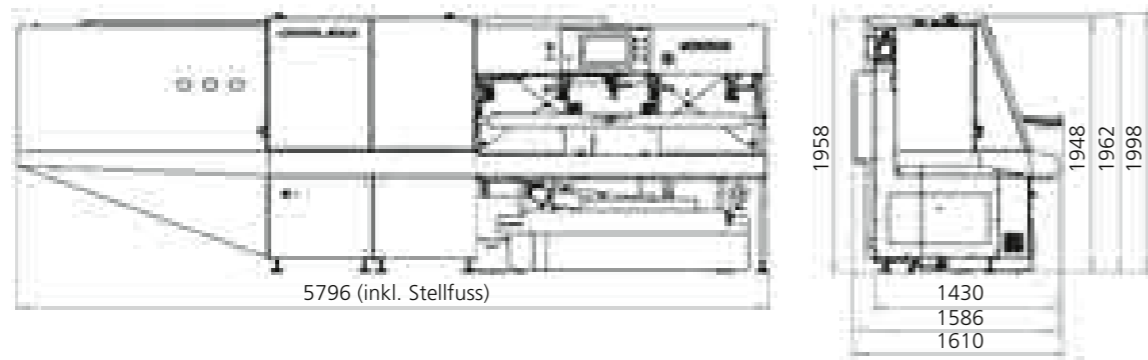

## CRYSTAL RACE

(OPTION 3D-STRUKTUREN | 3D STRUCTURES | STRUCTURES 3D | IMPRONTE 3D)



12 / h

Allround-Roboter mit einem Stein für einen Ski.

Allround-robot with one stone for one ski.

Robot Allround avec une pierre pour un ski.

Robot versatile con una pietra per un sci.

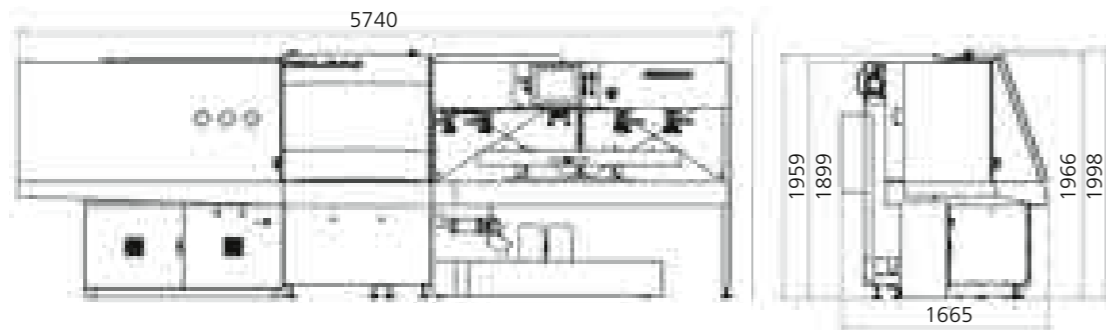

Die high-tech Strukturmaschine für den Rennsport. Für Ski bis zu 230 cm. Für die Seitenkantenpräparation mit GRIPtech Qualität.

The high tech structuring machine for the race departments. For skis up to 230 cm. For side edge preparation with GRIPtech quality.

La machine haute gamme pour les structures des skis de course. Pour les skis jusqu'à 230 cm. Pour la préparation des carres latérales avec la qualité GRIPtech.

La macchina ad alta tecnologia per le impronte per i sci da gara. Per gli sci fino a 230 cm. Per la preparazione delle lamine laterali con qualità GRIPtech.

## CRYSTAL ONE 2.0

AUTOMATISCHE UND KOMPAKTE SERVICE-STATION DER NEUESTEN GENERATION



15 / h

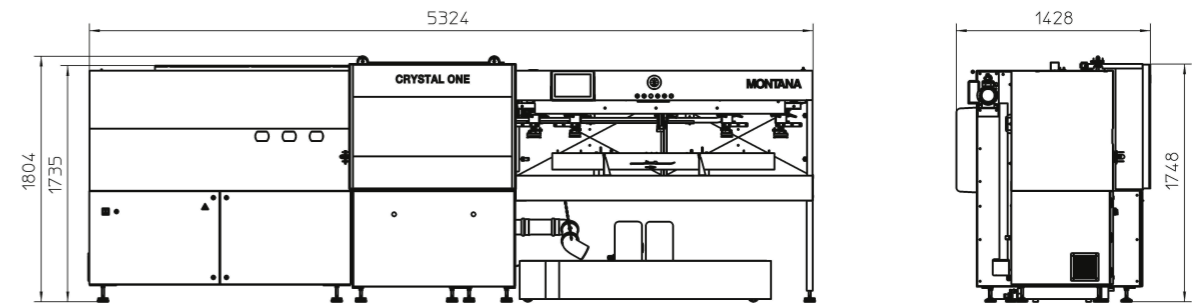

Mit der CRYSTAL ONE 2.0 optimieren Sie Ihre Service-Prozesse und bleiben stets auf dem neuesten Stand bezüglich Leistung, Effizienz und Technik.

With CRYSTAL ONE 2.0 you can optimise your service processes and always remain at the cutting edge of performance, efficiency and technology.

La CRYSTAL ONE 2.0 vous permet d'optimiser tous les processus de service et de demeurer à jour pour ce qui est de la performance, de l'efficacité et de la technologie.

Con CRYSTAL ONE 2.0 potete ottimizzare i vostri processi di manutenzione e rimanere sempre aggiornati in merito a prestazione, efficienza e tecnologia.

## OPTION 3D STRUKTUREN – CRYSTAL RACE

3D-STRUKTUREN | 3D STRUCTURES | STRUCTURES 3D | IMPRONTE 3D

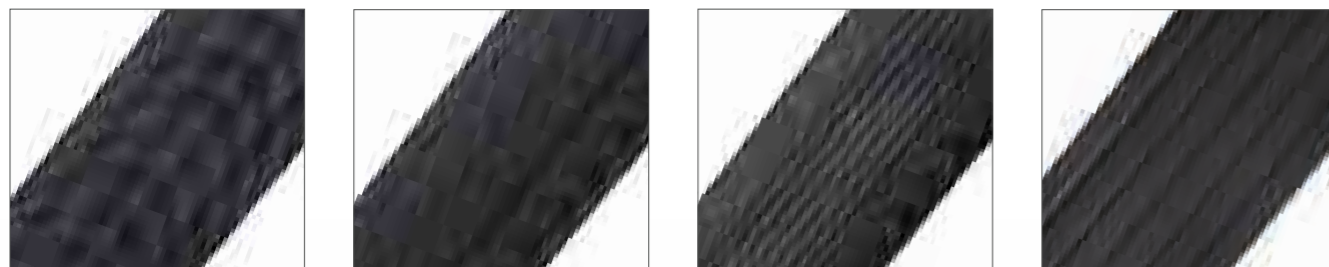

Dreidimensionale Skilauffläche geschliffen mit Strukturen. Die Zukunft des Gleitens!

Three-dimensional running base grinded with structures! The future of gliding!

Base en 3D poncé avec structures. Le future du glissement!

Soletta tridimensionale rettificata con impronte. Il futuro del gliding!

## CRYSTAL INLINE II BASIC

STEINSCHLIFF KOMBIMASCHINE | STONE GRINDING | AFFÛTAGE À PIERRE | AFFILATURA A MOLA

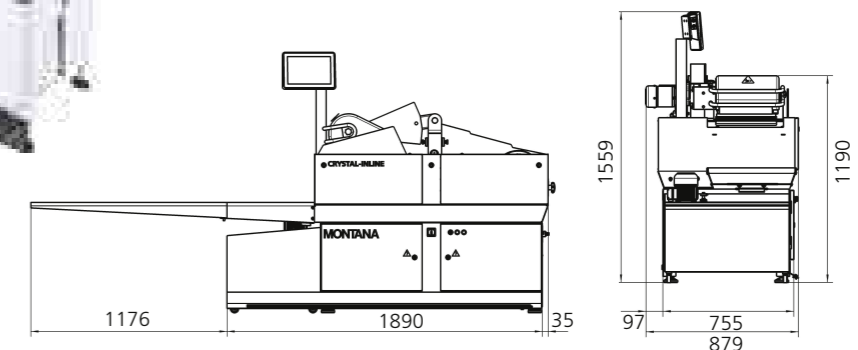

Die komplett überarbeitete universelle Kombimaschine für Ski und Snowboards stellt die perfekte Lösung für kleinere bis mittlere Werkstätten dar.

The completely revised universal combination machine for skis and snowboards is the perfect solution for small to medium-sized workshops.

L'appareil universel combiné pour skis et snowboards, entièrement repensé, représente la solution parfaite pour les ateliers de petite et moyenne taille.

La macchina combinata universale completamente rivista per sci e snowboard rappresenta la soluzione perfetta per officine di piccole e medie dimensioni.

## CRYSTAL INLINE II RACE

RENNLAUF KOMBIMASCHINE | RACING COMBINATION MACHINE | APPAREIL COMBINÉ DE COMPÉTITION  
MACCHINA COMBINATA PER LA PREPARAZIONE DI SCI E SNOWBOARD DA GARA

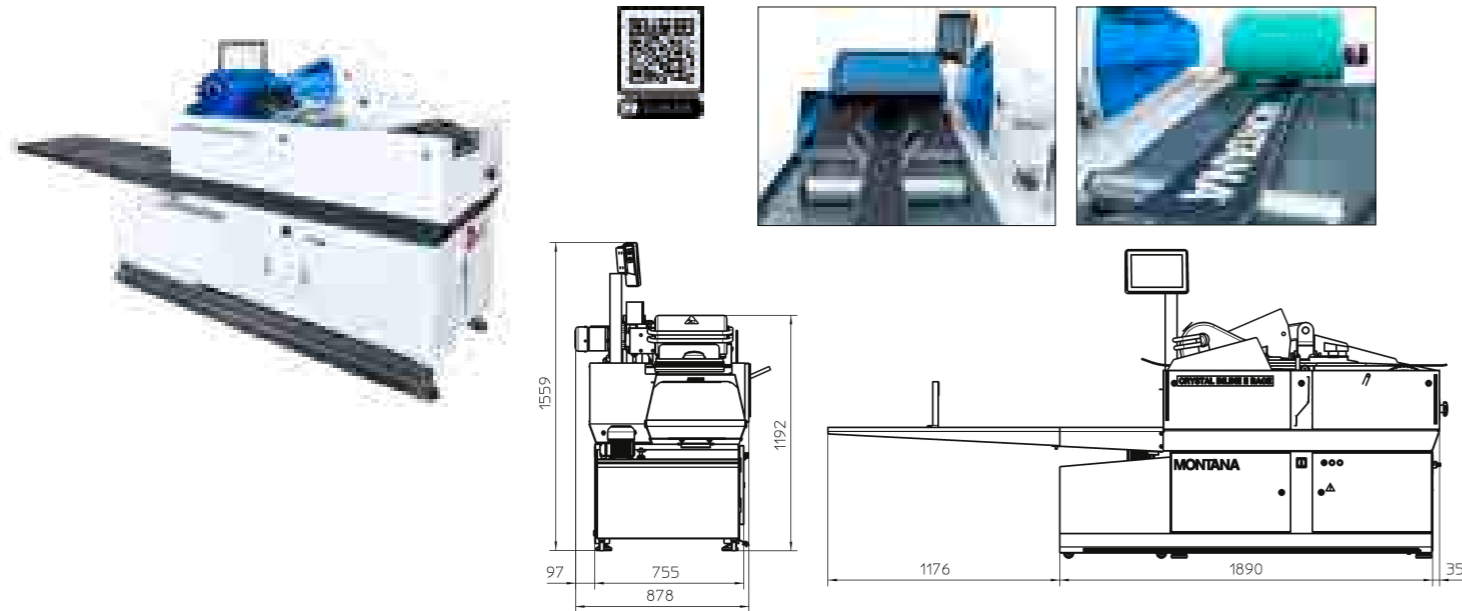

Die CRYSTAL INLINE II RACE ist eine hochmoderne und professionelle Steinschleifmaschine, die speziell für den Rennlauf konzipiert wurde.

The CRYSTAL INLINE II RACE is an ultra-modern, professional stone-grinding machine that has been specially designed for racing.

LaCRYSTAL INLINE II RACE est une machine d'affûtage à pierre professionnelle, à la pointe du progrès, et conçue spécialement pour la compétition.

La CRYSTAL INLINE II RACE è una modernissima rettificatrice a mola professionale, concepita specialmente per le gare sciistiche.

## CRYSTAL CC RACE

DIE ERSTE WAHL FÜR DEN RENNSERVICE | FIRST CHOICE FOR RACE SERVICE  
LE PREMIER CHOIX POUR LE SERVICE DE COMPÉTITION | LA PRIMA SCELTA PER LA MANUTENZIONE DA GARA

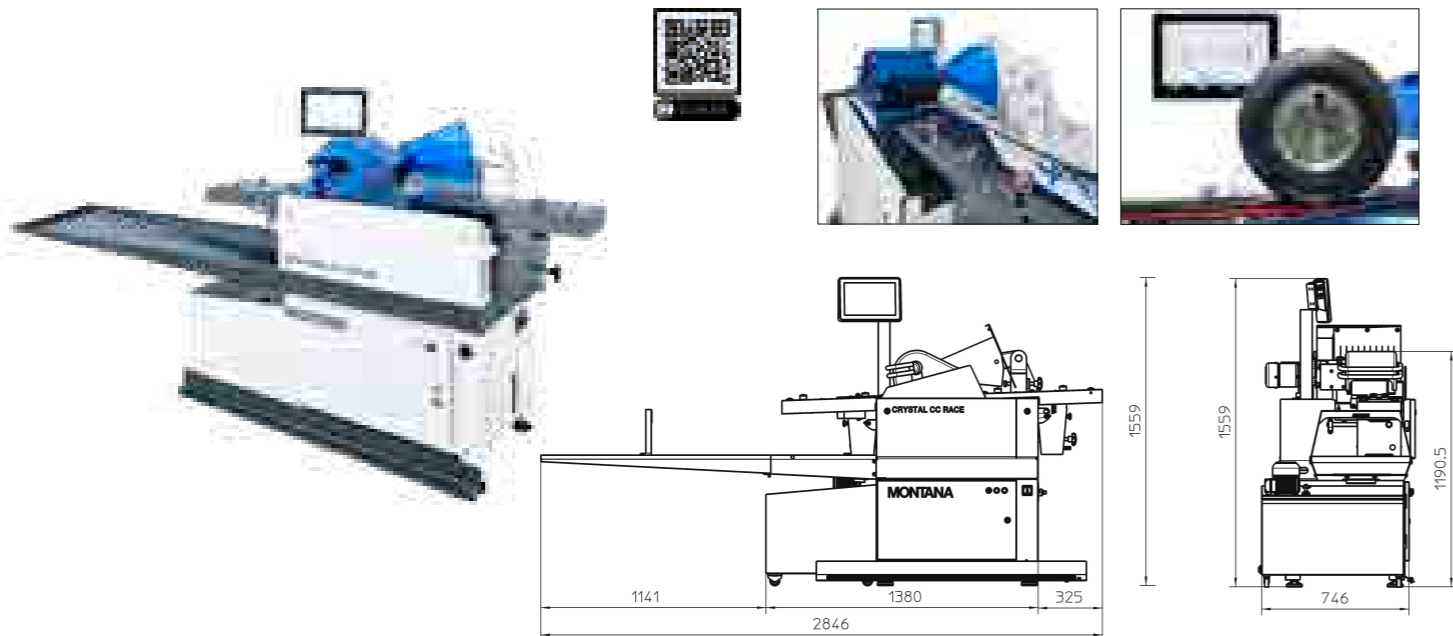

Die CRYSTAL CC RACE ist die innovative Rennlauf-Steinschleifmaschine für Langlauf und Alpin-Ski.

The CRYSTAL CC RACE is the innovative racing stone grinding machine for cross-country and alpine skiing.

La CRYSTAL CC RACE est une machine d'affûtage innovante de compétition dédiée au ski de fond et alpin.

La CRYSTAL CC RACE è un'innovativa rettificatrice a mola per sci di fondo e sci alpino.

Swisski OFFICIAL SUPPLIER



## P-TEX SPEEDMASTER II

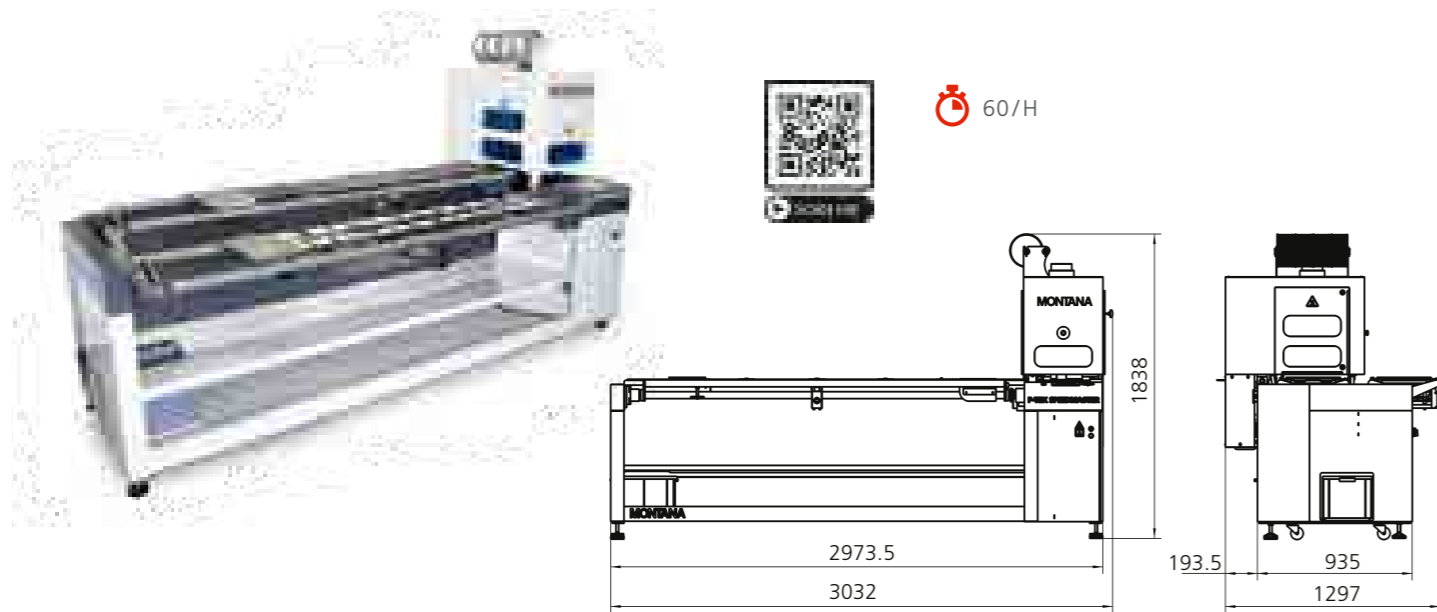

High-Speed Belagsaufschmelz-Automat.

Automatic high speed resoler for base repair.

Surmouleuse automatique high speed.

Macchina automatica per la riparazione delle solette.

## MRS 180



Halbautomatischer Belagsaufschmelzer mit Aufschmelzkopf 180 mm.

Semi-automatic resoler with melting head 180 mm.

Surmouleuse semi-automatique avec tête de surmoulage 180 mm.

Macchina semiautomatica per la riparazione delle solette con testata di fusione 180 mm.

## P-TEX MASTER II

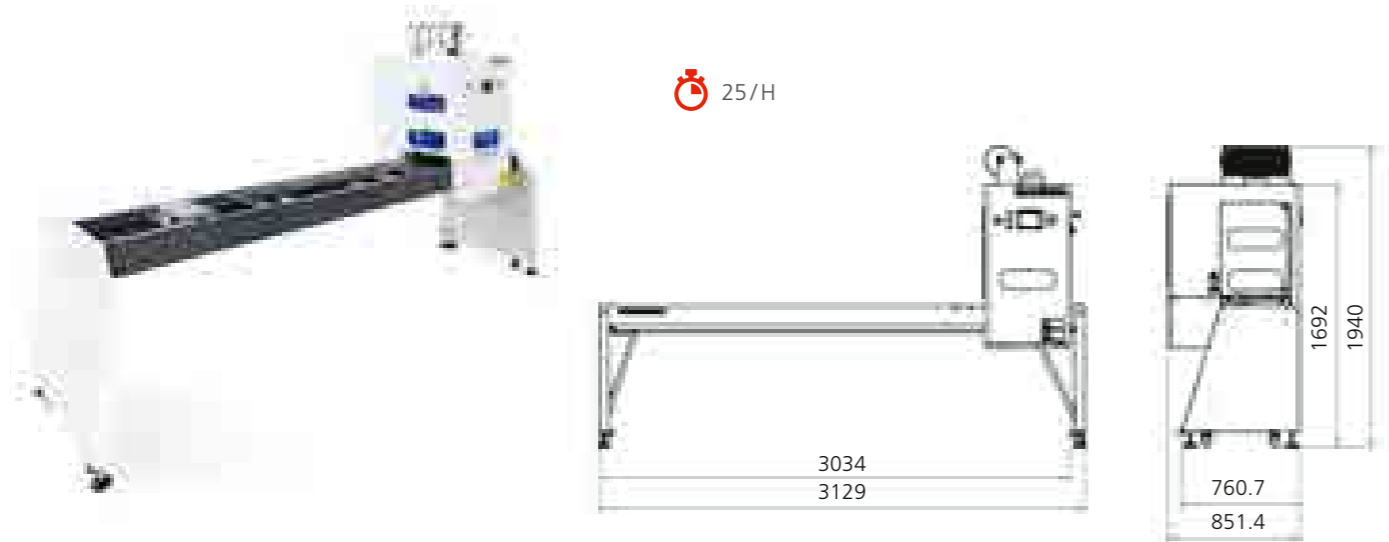

Belagsaufschmelzautomat mit hoher Leistung.

Automatic base resoler with highest capacity.

La surmouleuse à haut rendement.

Macchina da fusione del rivestimento ad alta potenza.

## MONTY EXTRUDER



Handgerät für Belagsreparaturen. Mit Aabsaugung.

Hand extruder for base repair. With extraction.

Appareil manuel pour la réparation de la semelle. Avec aspiration.

Macchina manuale per la riparazione delle solette. Con aspirazione.

## MONTY BELT

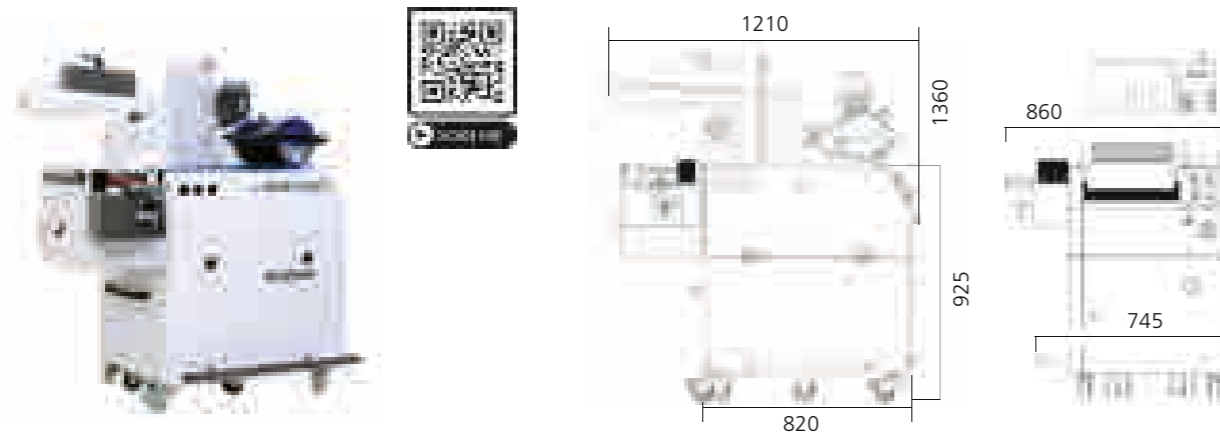

Die modulare Bandschleifmaschine in drei Versionen.

The modular belt sander in three versions.

La ponceuse à bande large polyvalente disponible en trois versions.

La rettificatrice a nastro modulare in tre versioni.

## RACE EDGE



Kompakte Finish-Anlage für den perfekten Seitenkanten-Rennschliff.

Compact side edge polishing machine for the perfect race edge finish.

Machine compacte pour une finition latérale digne d'un service course.

Compatto impianto di finitura per la perfetta finitura da corsa dei bordi laterali.

## COMPACT EDGE S / ST

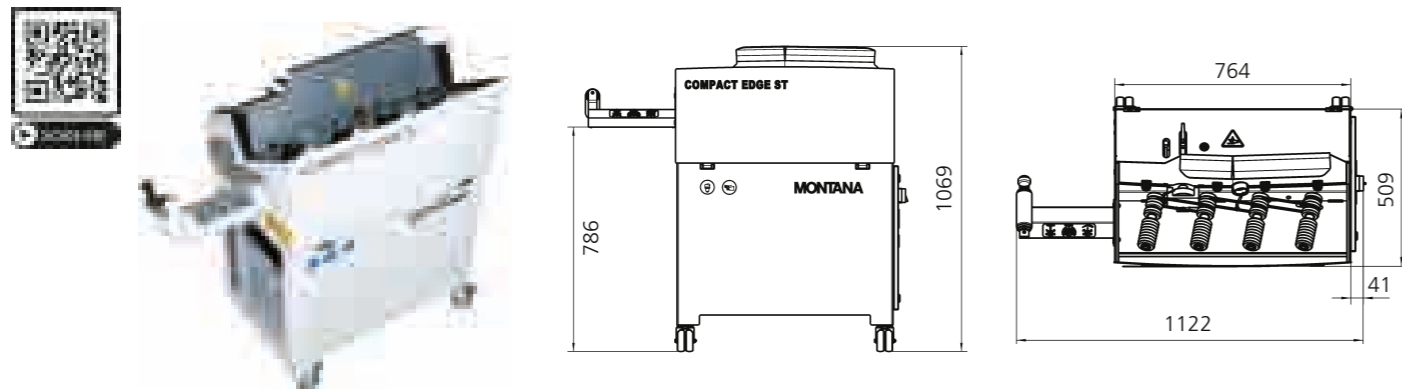

Kompakte Anlage für die Präparation der Seitenkante mit RACE EDGE-Finish. Bei Compact Edge ST inkl. Tuning.

Compact system for preparing the side edge with RACE EDGE Finish. Compact Edge ST with integrated tuning.

Installation compacte pour la préparation des carres latérales avec RACE EDGE Finish. Compact Edge ST avec tuning intégré.

L'impianto compatto per la preparazione delle lamine con RACE EDGE Finish. Compact Edge ST con tuning integrato.

## MCS 2000

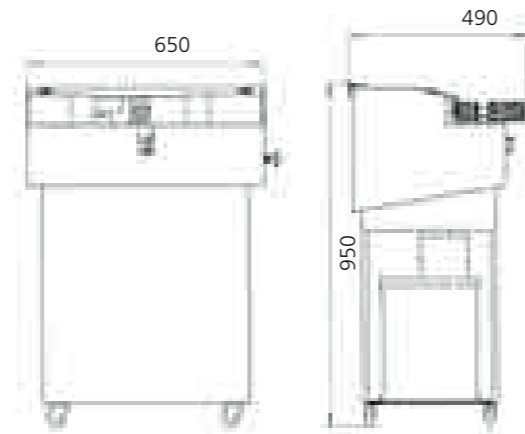

Die kompakte Seitenkanten-schleifmaschine.

The compact side edge grinding machine.

Affûteuse compacte pour carres latérales.

La rettificatrice compatta per i bordi laterali.

## FLUID WAXER 4

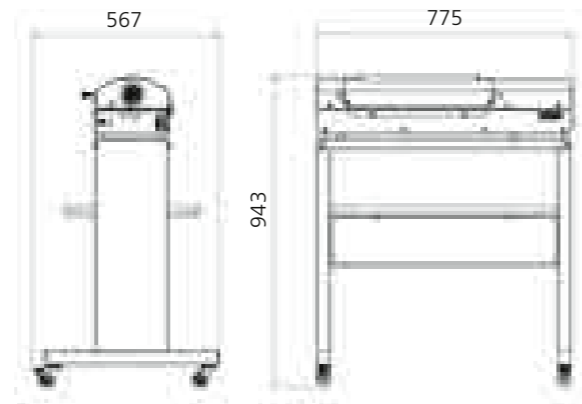

Die ideale Flüssig- und Heisswachs-maschinen für Ski und Boards.

The very best liquid and hot wax machines for skis and snowboards.

Des machines de fartage à chaud et liquide, idéales pour les skis et les snowboards.

Macchine per sciolina liquida e a caldo, ideali per sci e snowboard.

## WAXMASTER II

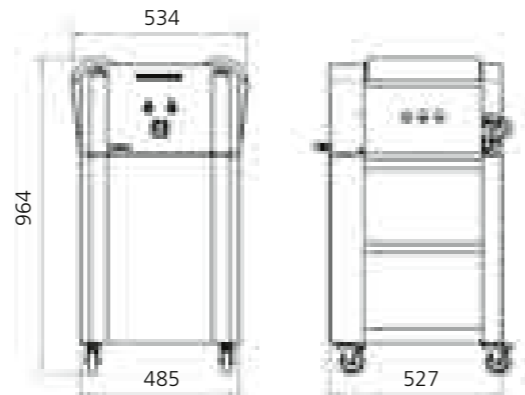

Wachsen und Polieren in einem Arbeitsgang. Mit grosser Wachs- und Polierrolle.

Waxing and polishing in one operation. With large waxing and polishing roles.

Fartage et polissage en un seule passage. Avec grande rouleaux fartage et polissage.

Sciolinatura e lucidatura in un unico passaggio. Con grandi rulli per sciolinatura e lucidatura.

## WAXMASTER I

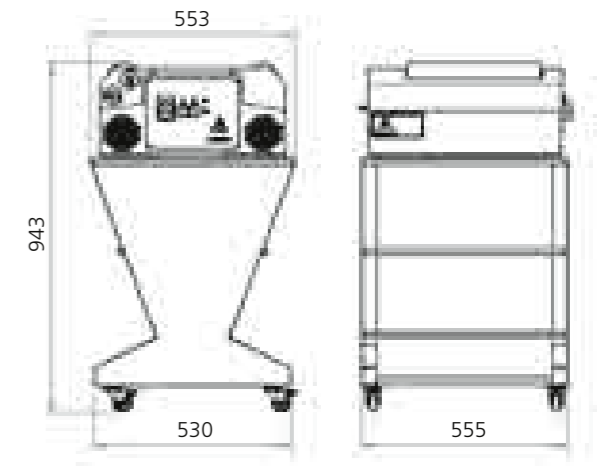

Wachsen und Polieren in einem Arbeitsgang.

Waxing and polishing in one operation.

Fartage et polissage en un seule passage.

Sciolinatura e lucidatura in un unico passaggio.

## MAXIMA



Universal Polierrmaschine.

All-purpose polishing machine.

Brosse universelle.

Lucidatrice universale.

## JETBOND S & JETBOND M

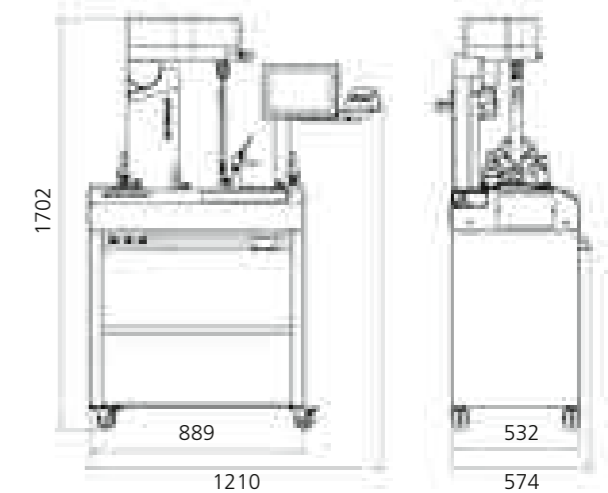

Die schnellen und automatisierten Bindungsmessgeräte. Sind in zwei Modellen verfügbar.

The fast and automatic binding adjustment devices. They are available in two models.

Machine rapide et automatique pour le contrôle des fixations. Disponible en deux modèles.

Gli strumenti di regolazione degli attacchi rapidi e automatizzati. Disponibili in due modelli.

## RACE WAXER TC



30 / h

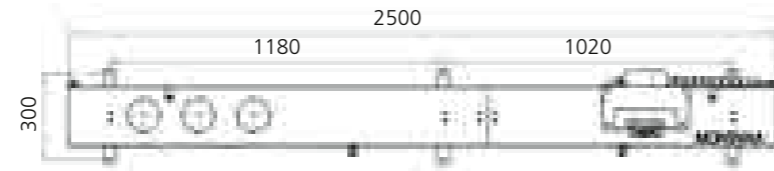

Die Infrarot-Wachstechnologie mit Thermo-Control für hohes Serviceaufkommen. Erhältlich mit 1 oder 2 Infrarot-Lampen.

The infrared wax technology with Thermo-Control for professional use. Available with 1 or 2 infrared lamps.

La technologie du fartage par infrarouge avec Thermo-Control pour l'utilisation professionnelle. Disponible avec 1 ou 2 lampes infrarouge.

Sciolinatura professionale ad infrarossi con Thermo-Control. Disponibile con 1 o 2 lampade infrarosse.

## RACE WAXER MOBILE



15 / h

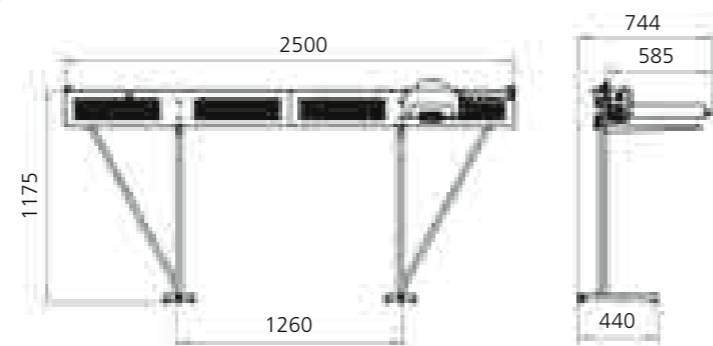

Portable Infrarot-Wachstechnologie.

Portable infrared wax technology.

Technologie du fartage par infrarouge pouvant être facilement déplacée.

Sciolinatura ad infrarossi professionale e trasportabile.



printed in  
**switzerland**



[linkedin.com/company/montanaworldofexcellence](https://www.linkedin.com/company/montanaworldofexcellence)



[facebook.com/montanasportinternational](https://www.facebook.com/montanasportinternational)



[youtube.com/skiservicemontana](https://www.youtube.com/skiservicemontana)



[instagram.com/montanasportinternational](https://www.instagram.com/montanasportinternational)